



---

SKIRTING BOARDS

# MORE THAN... JUST SKIRTING BOARDS

Innovation, quality and know-how. Since 1994 we've been investing in knowledge, technology and our machinery park.

We aim to become market LEADER wherever we are present. We are pushing forward and strive for more to deliver accessories perfectly matched to the products.



## WE TRY HARDER, WE ARE THE FLOOR EXPERT



## DESIGN

Every year A.DESIGN STUDIO analyzes trends, changes in consumer preferences and hundreds of new floor colors. That's why we can create customer orientated solutions and stay relevant.

## TECHNOLOGY

Our inhouse laboratory is testing hundreds of floors from all major manufacturers to improve our accessories and create functional floor system. That's why, we know the strongest and weakest points of all types of floors. We are also testing our underlays to deliver top quality solutions for different floor types.

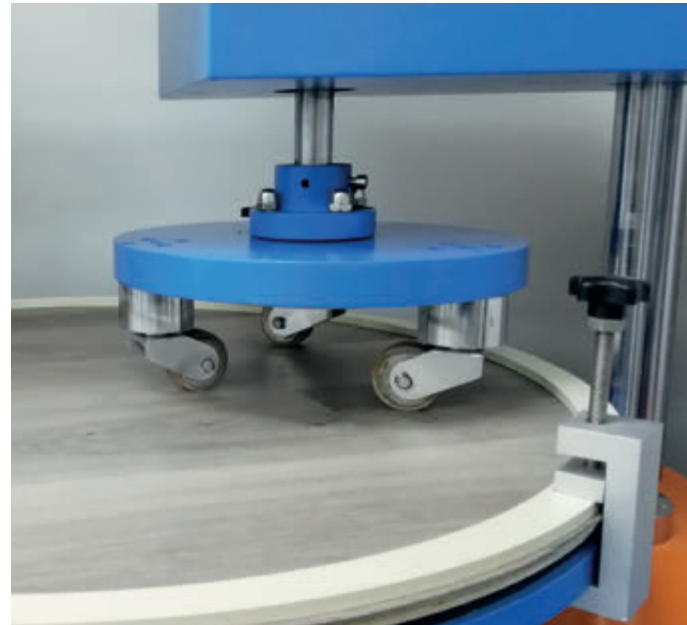

## MANUFACTURE

We are an European leader for production of floor accessories. Our technological development allows us to offer great portfolio of products in various technologies.



# SKIRTING BOARDS

## SOLID CORE COLLECTIONS

**TORE** NEW



**VIGO** NEW



## NON-PVC WATERPROOF COLLECTIONS

**AVIA** NEW



**STIQ**



**DORA**



**VEGA**



**INTEGRA**

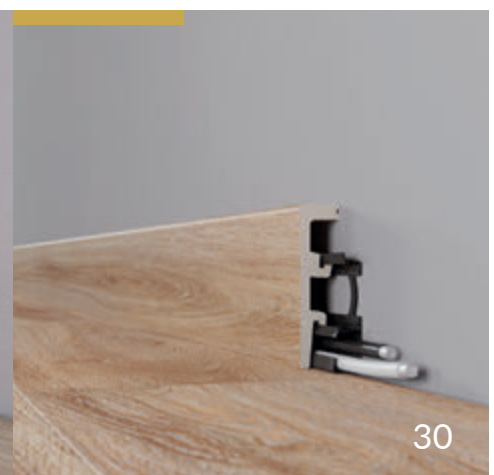



## MODERN PVC COLLECTIONS

### INDO

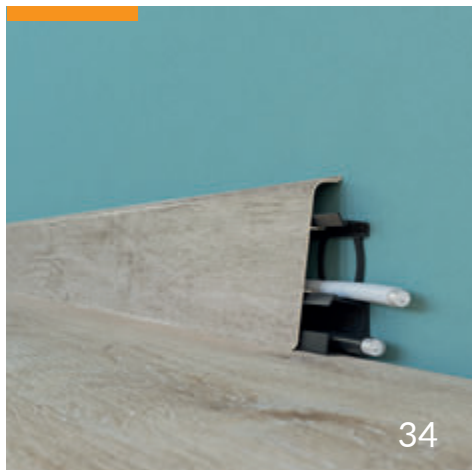

### LARS



### MACK



## TRADITIONAL PVC COLLECTIONS

### LM60



### LM55



## TRADITIONAL MDF COLLECTIONS

### CAVARE



### PAINT IT



### DIAMOND



# SOLID CORE SKIRTING BOARDS

## **TORE**

We do not limit ourselves and stop pushing towards innovation. That is what drives us to create new products. Initially we have set an ambitious goal for new our skirting board.

TORE is our new hybrid skirting board produced in a brand new technology giving it a 100% water resistance as well as a higher abrasion resistance. Due to the highly advanced technology of digital printing - piezoelectric UV LED with high-resolution (up to 1800 dpi), we gained an unprecedented fidelity to raw materials at the surface of the skirtings boards, which now look like actual wood, stone or concrete. It allowed us to ideally match design of the skirtings not only with our floors but also with the most popular designs on the market.

**PERFECT MATCH**



**DEEP MATT SURFACE**



**100% WATERPROOF**



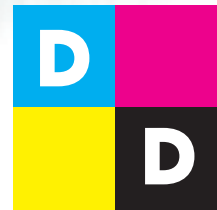

**DIGITAL  
DESIGN**

With a multistep process of production TORE gains a perfect matte surface. As a result, skirtings boards obtain a deep thread design enriching each interior and underlining its beauty. More importantly, used technologies provide the resistance to UV light - the design of the skirtings stays protected for years without discoloration and the colour remains as intensive as at the moment of installation. Except for the design, we also took care of the practicality. Due to the water resistance and matte surface, TORE is easy to clean. It will not be damaged in the process of scrubbing or vacuuming.

In addition, our product is environmentally safe. The printing technology is using the VOC Free and solvent-free inks and is eco-friendly. All these factors resulted in an excellent product which we are proud to share with you.



# SOLID CORE SKIRTING BOARDS

**VIGO**

IT IS TIME TO END WITH DIFFICULT CHOICES.

Thanks to our solutions we've created the skirting board in hybrid technology. Now, you have high quality surface of lacquered MDF skirtings and the flexibility and waterproofness of PVC skirtings.

What else?

Easy assembly and dirt resistance. Thanks to the additional flexible and integrated seals, we have waterproof barrier on two sides - from the wall and from the floor.

**NO SILICONE NEEDED**  
FASTER INSTALLATION

**WATERPROOF**  
CLEAN YOUR FLOOR WITHOUT  
ANY RISK – NON-DEFORMING,  
WATER RESISTANT BOARD!

**EASY CUT**  
NO SPECIAL  
TOOLS

**ACCESSORIES**  
PERFECT CORNERS



**HYBRID**  
TECHNOLOGY



**FLEXIBLE**  
ADAPTATION  
TO UNEVEN WALLS

LET'S TAKE WITH US  
A STEP INTO THE FUTURE.  
LET'S VIGO

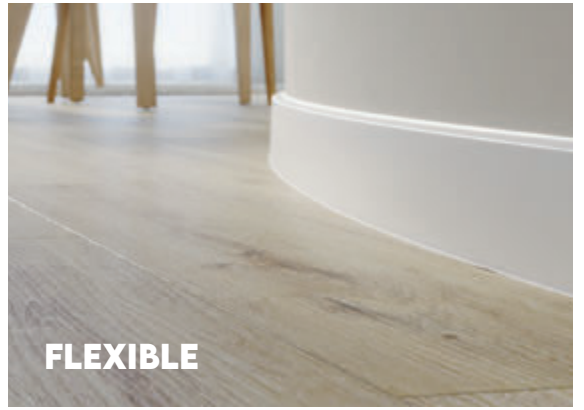

**FLEXIBLE**



**WATERPROOF**



**NO SILICONE NEEDED**



**EASY CUT**



**ACCESSORIES**



# TORE NEW

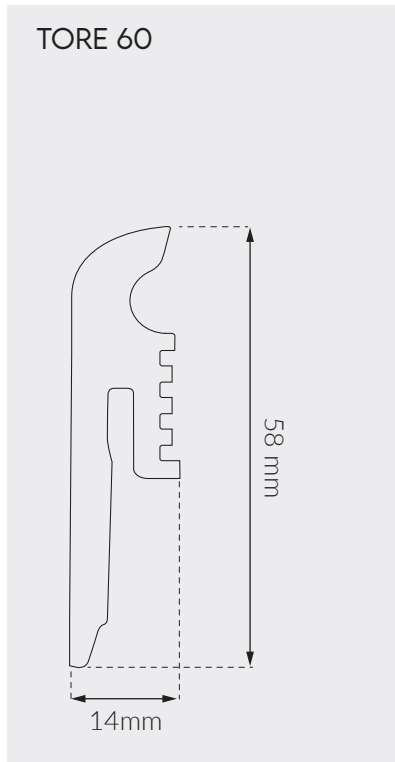
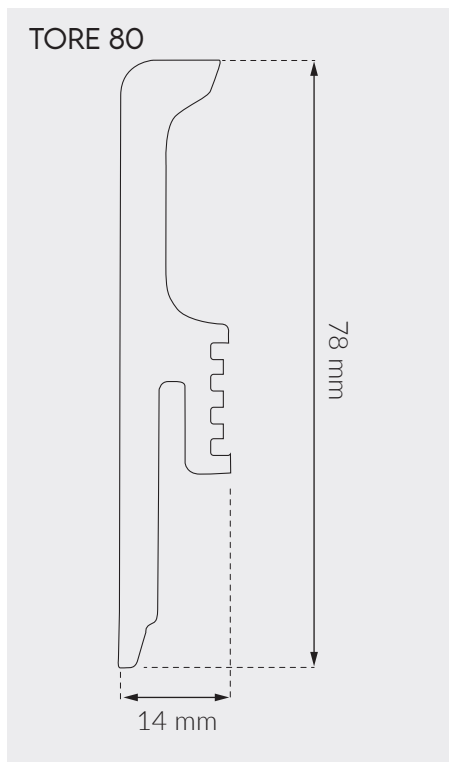
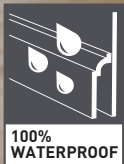

- > SOLID CORE SKIRTING BOARD
- > HIGH RESOLUTION WOOD DESIGN PRINTING
- > DEEP MATT SURFACE
- > 100% WATERPROOF SKIRTING BOARDS
- > FLEXIBLE CORE, PERFECT FOR ANY KIND OF WALL
- > INSTALLATION WITH GLUE OR CLIPS
- > GLUING CHANNEL

	SKIRTING	STRONGMAN GLUE	CLIPS AND DOWELS
cm /	220 cm	-	ø 6 mm
	-	1 pc	20 pcs
	22 m	12 pcs	1200 pcs
	770 m	5905167788264	5905167826737





102 | ALASKAN OAK

TORE 60	5905167835388
TORE 80	5905167835777



103 | BERGEN OAK

TORE 60	5905167835395
TORE 80	5905167835784



104 | CANADIAN OAK

TORE 60	5905167835401
TORE 80	5905167835791



105 | CONEY OAK

TORE 60	5905167835418
TORE 80	5905167835807



108 | DAKOTA OAK

TORE 60	5905167835449
TORE 80	5905167835838



117 | LAHTI OAK

TORE 60	5905167835531
TORE 80	5905167835920



112 | BOLOGNA OAK

TORE 60	5905167835487
TORE 80	5905167835876



124 | CAMDEN OAK

TORE 60	5905167835609
TORE 80	5905167835999



116 | ARGOS OAK

TORE 60	5905167835524
TORE 80	5905167835913



115 | OREGON OAK

TORE 60	5905167835517
TORE 80	5905167835906



109 | GEORGIA OAK

TORE 60	5905167835456
TORE 80	5905167835845



151 | BAKER CONCRETE

TORE 60	5905167835678
TORE 80	5905167836064



152 | HAMBURG CONCRETE

TORE 60	5905167835685
TORE 80	5905167836071



149 | GLACIER CONCRETE

TORE 60	5905167835654
TORE 80	5905167836040



150 | TOKIO CONCRETE

TORE 60	5905167835661
TORE 80	5905167836057



119 | TORONTO CONCRETE

TORE 60	5905167835555
TORE 80	5905167835944



120 | MIAMI CONCRETE

TORE 60	5905167835562
TORE 80	5905167835951



121 | BROOKLYN CONCRETE

TORE 60	5905167835579
TORE 80	5905167835968



122 | BROADWAY CONCRETE

TORE 60	5905167835586
TORE 80	5905167835975



123 | MANHATTAN CONCRETE

TORE 60	5905167835593
TORE 80	5905167835982



118 | SOHO CONCRETE

TORE 60	5905167835548
TORE 80	5905167835937



113 | PANAMA OAK

TORE 60	5905167835494
TORE 80	5905167835883



158 | HARLOW OAK

TORE 60	5905167835746
TORE 80	5905167836132



106 | PORTLAND OAK

TORE 60	5905167836941
TORE 80	5905167835814



107 | PASADENA OAK  
TORE 60 5905167836934  
TORE 80 5905167835821



169 | WEISSHORN OAK  
TORE 60 5905167843178  
TORE 80 5905167843215



157 | RIDGEFIELD OAK  
TORE 60 5905167835739  
TORE 80 5905167836125



167 | PRESTON OAK  
TORE 60 5905167839430  
TORE 80 5905167839447



145 | WELLINGTON OAK  
TORE 60 5905167835616  
TORE 80 5905167836002



114 | WILIAMSBURG OAK  
TORE 60 5905167835500  
TORE 80 5905167835890



159 | WEMBLEY OAK  
TORE 60 5905167835753  
TORE 80 5905167836149



156 | LEONARD OAK  
TORE 60 5905167835722  
TORE 80 5905167836118



155 | MAYNE OAK  
TORE 60 5905167835715  
TORE 80 5905167836101



146 | BELFORD OAK  
TORE 60 5905167835623  
TORE 80 5905167836019



168 | GAILLARDE OAK  
TORE 60 5905167843161  
TORE 80 5905167843208



170 | PATENDORF OAK  
TORE 60 5905167843185  
TORE 80 5905167843222



110 | YAKIMA OAK  
TORE 60 5905167835463  
TORE 80 5905167835852



111 | NEVADA WALNUT  
TORE 60 5905167835470  
TORE 80 5905167835869



153 | YANKEE OAK  
TORE 60 5905167835692  
TORE 80 5905167836088



171 | STAMBERGER OAK  
TORE 60 5905167843192  
TORE 80 5905167843239



154 | SIERRA OAK  
TORE 60 5905167835708  
TORE 80 5905167836095



147 | GEORGETOWN OAK  
TORE 60 5905167835630  
TORE 80 5905167836026



148 | GRANTS OAK  
TORE 60 5905167835647  
TORE 80 5905167836033





# VIGO 80 NEW

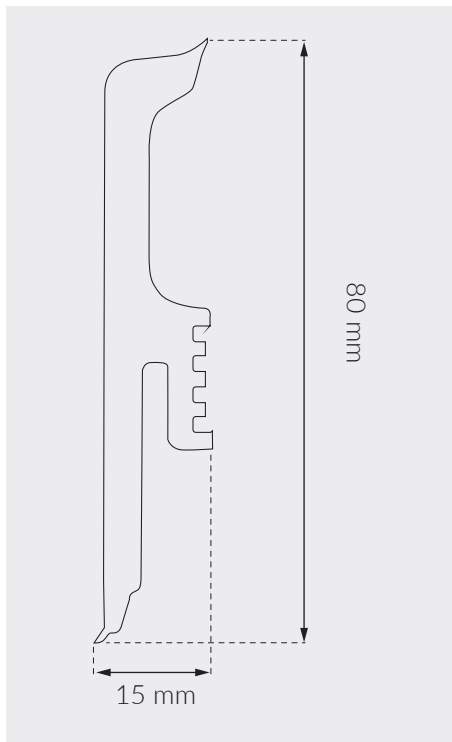
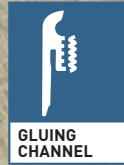

- > HYBRID TECHNOLOGY
- > NO NEED FOR SILICONE
- > FLEXIBLE AND DURABLE
- > PROTECTIVE LAYER
- > WATERPROOF AND DIRT RESISTANCE
- > QUICK INSTALLATION
- > GLUING CHANNEL

SKIRTING	STRONGMAN GLUE	CLIPS AND DOWELS	ACCESSORIES				
220 cm	-	ø 6 mm	ACCESSORIES				
-	1 pc	20 pcs	2 pcs	2 pcs	2 pcs	1L+1R	
22 m	12 pcs	1200 pcs	30 pcs	30 pcs	30 pcs	30 pcs	
770 m	5905167788264	5905167826737					



01 | White RAL 9003  
 SKIRTING 5905167826478  
 CS PROFILE 40



03 | Dark Gray RAL 7042  
 SKIRTING 5905167826492  
 CS PROFILE A1

## PERFECT CORNERS



## CUTTING METHODS OF CORNERS:



### MANUAL CUTTING

The possibility of cutting corners with a hand saw



### MITRE SAW

The possibility of cutting corners with a mitre saw



# VIGO 60 NEW

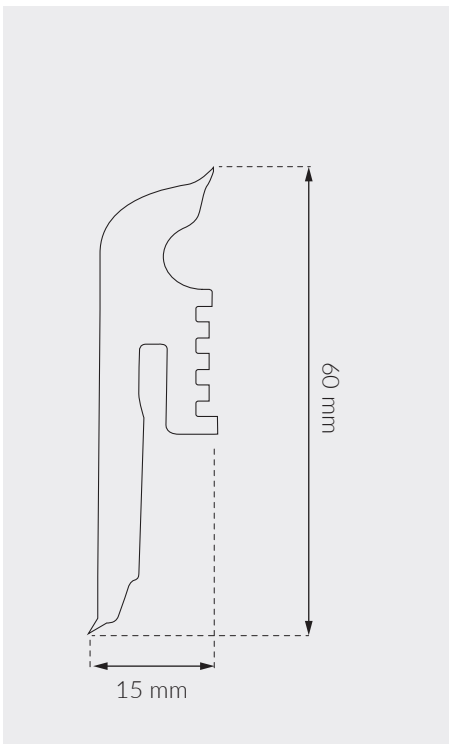
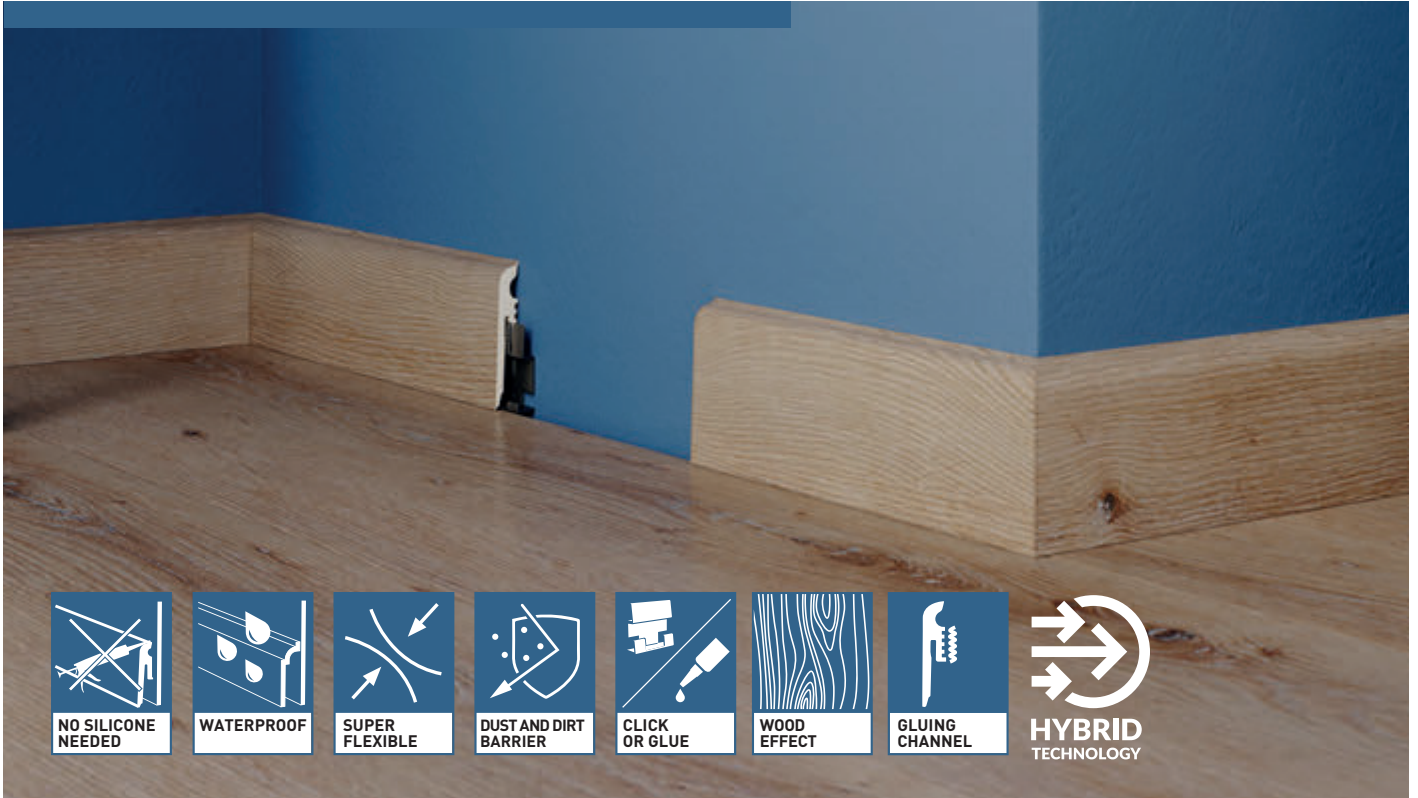

- > HYBRID TECHNOLOGY
- > NO NEED FOR SILICONE
- > FLEXIBLE AND DURABLE
- > PROTECTIVE LAYER
- > WATERPROOF AND DIRT RESISTANCE
- > QUICK INSTALLATION
- > GLUING CHANNEL

							
	SKIRTING	STRONGMAN GLUE	CLIPS AND DOWELS				ACCESSORIES 
	220 cm	-	ø 6 mm				
	-	1 pc	20 pcs	2 pcs	2 pcs	2 pcs	1L+1R
	22 m	12 pcs	1200 pcs	30 pcs	30 pcs	30 pcs	30 pcs
	770 m	5905167788264	5905167826737				





01 | White RAL 9003  
SKIRTING 5905167825679  
CS PROFILE 40



02 | Gray RAL 7035  
SKIRTING 5905167825686  
CS PROFILE A1

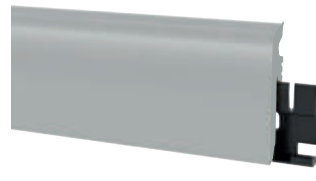

03 | Dark Gray RAL 7042  
SKIRTING 5905167825693  
CS PROFILE 45

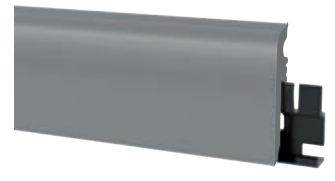

04 | Anthracite RAL 7024  
SKIRTING 5905167825709  
CS PROFILE 52



102 | Scandinavian Oak  
SKIRTING 5905167825716  
CS PROFILE 19



112 | Bradford Oak  
SKIRTING 5905167825723



107 | Vermont Oak  
SKIRTING 5905167825747  
CS PROFILE 20



158 | Monument Oak  
SKIRTING 5905167825730  
CS PROFILE 158



159 | Newport Oak  
SKIRTING 5905167825754  
CS PROFILE 159



160 | Calvia Oak  
SKIRTING 5905167825761



161 | Goldberg Oak  
SKIRTING 5905167825778



163 | Rossport Oak  
SKIRTING 5905167825792  
CS PROFILE 29



154 | Sierra Oak  
SKIRTING 5905167825822  
CS PROFILE 47



110 | Jersey Oak  
SKIRTING 5905167825808  
CS PROFILE 07



147 | Georgetown Oak  
SKIRTING 5905167825815



162 | Cornwall Oak  
SKIRTING 5905167825785  
CS PROFILE 162

## CORNERS



## CUTTING METHODS OF CORNERS:



### MANUAL CUTTING

The possibility of cutting corners with a hand saw



### MITRE SAW

The possibility of cutting corners with a mitre saw



# NON-PVC WATERPROOF COLLECTIONS

WATERPROOF SOLUTION  
FOR LVT AND RIGID FLOOR

**AVIA** **NEW**



**STIQ**



# VEGA



26

# INTEGRA



28



24

# DORA



**100%**  
**PVC**  
**FREE**

Made of environmentally friendly material

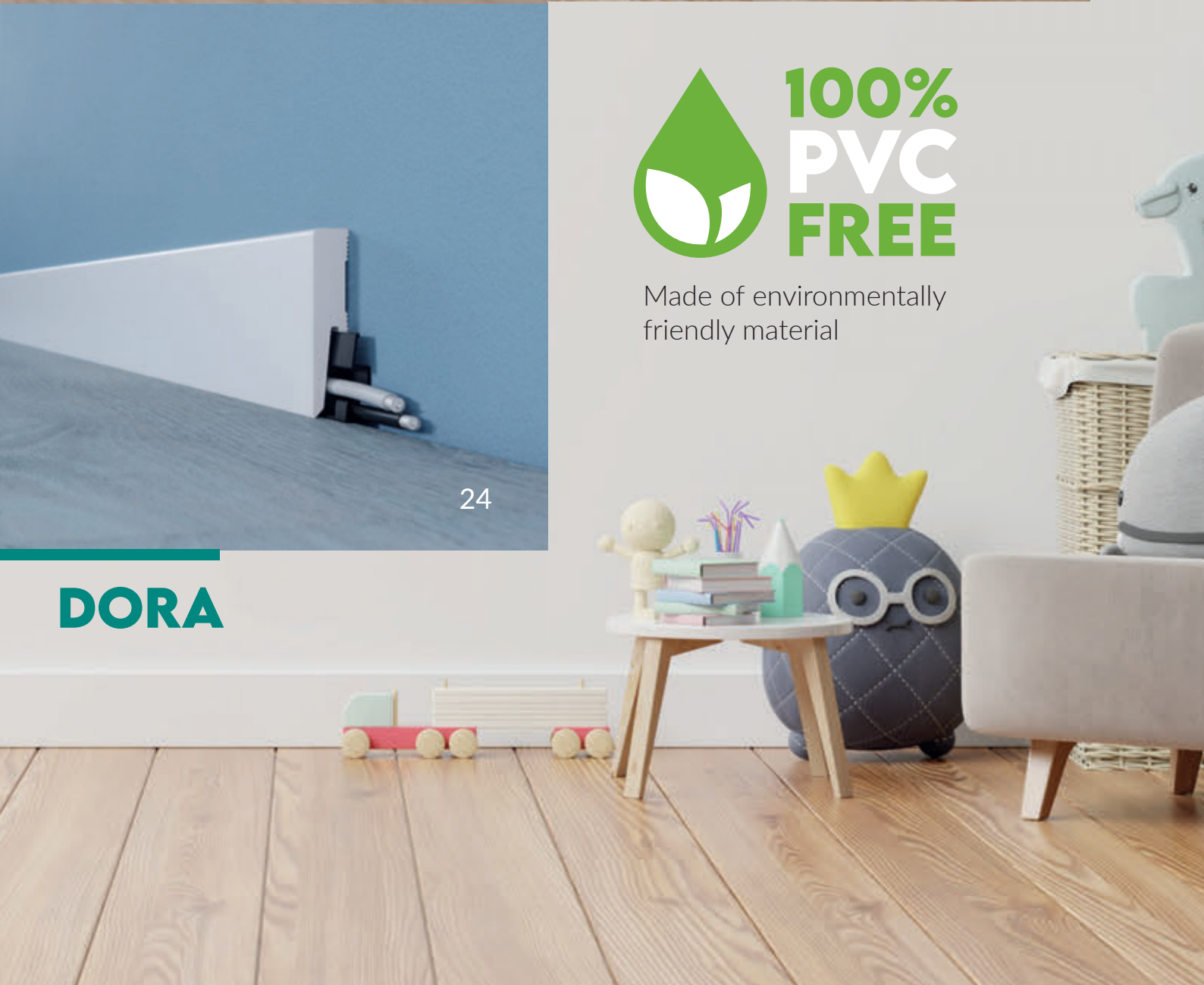



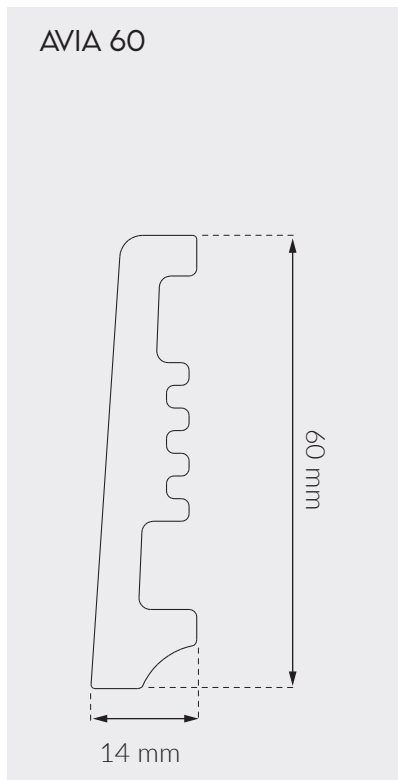
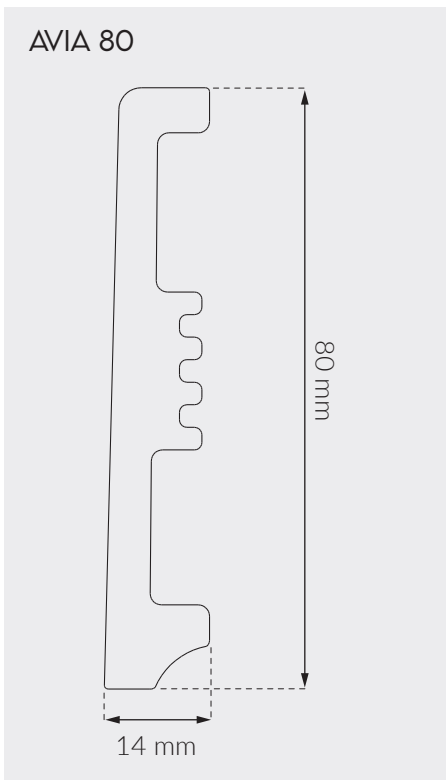

- > PERFECT FOR ECOMMERCE
- > WATERPROOF
- > JUST GLUE
- > DUST AND DIRT BARRIER
- > SUPER FLEXIBLE
- > 100% PVC FREE
- > DEDICATED TO VINYL FLOORING & LAMINAT

	SKIRTING	STRONGMAN GLUE	ACRYLIC
	200 cm	-	-
	-	1 pc	1 pc
	20 m	12 pcs	12 pcs
EAN	SEE NEXT PAGE	5905167788264	5907584890193



01 | White

ST610 5905167838877



04 | Anthracite

ST610 5905167838884



01 | White

ST810 5905167838891





04 | Anthracite

ST810 5905167838907

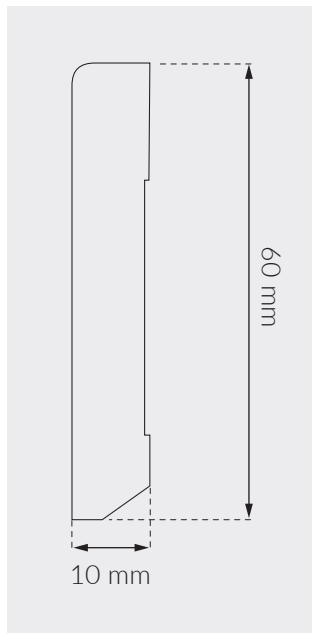



White  
 S0611 5905167817742  
 2,4 m  24 m

- > DUST AND DIRT BARRIER
- > WATERPROOF
- > JUST GLUE
- > SUPER FLEXIBLE
- > IMPACT RESISTANT
- > 100% PVC FREE
- > DEDICATED TO VINYL FLOORING & CERAMIC



				
	SKIRTING	STRONGMAN GLUE	TAPE	ACRYLIC
 	240 cm	-	-	-
	-	1 pc	1 pc	1 pc
	24 m	12 pcs	24 pcs	12 pcs
EAN	SEE NEXT PAGE	5905167788264	5905167731444	5907584890193



White

S0810 5905167817759

2,4 m 24 m



Light Grey

S0810 5905167817766

2,4 m 24 m



Grey

S0810 5905167817773

2,4 m 24 m

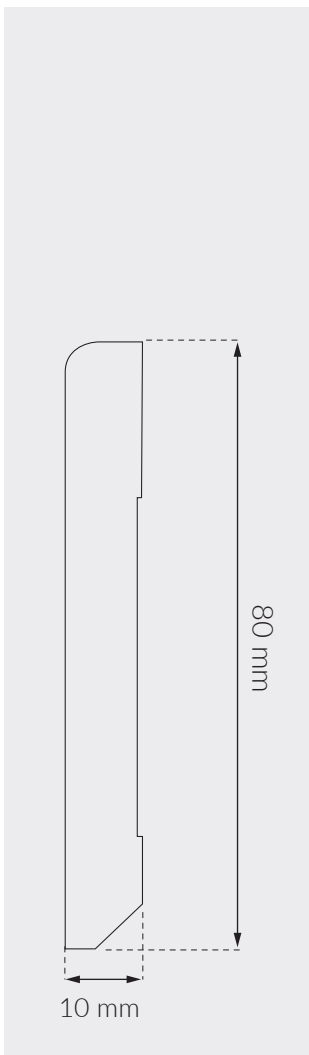

White

S0820 5905167817780

2,4 m 24 m

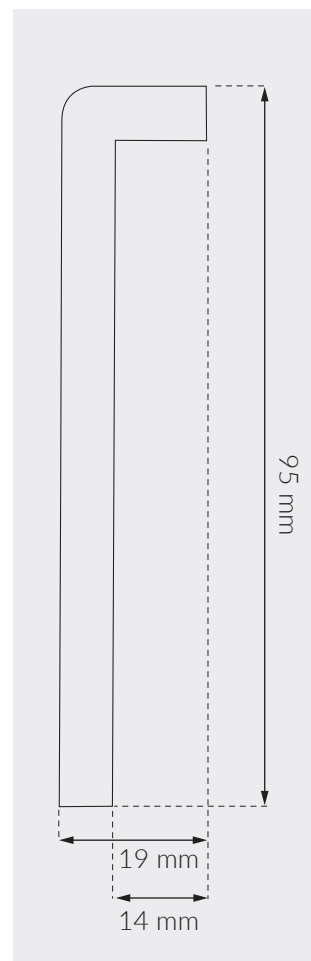

White

S0950 5905167817797

2,4 m 24 m



# DORA

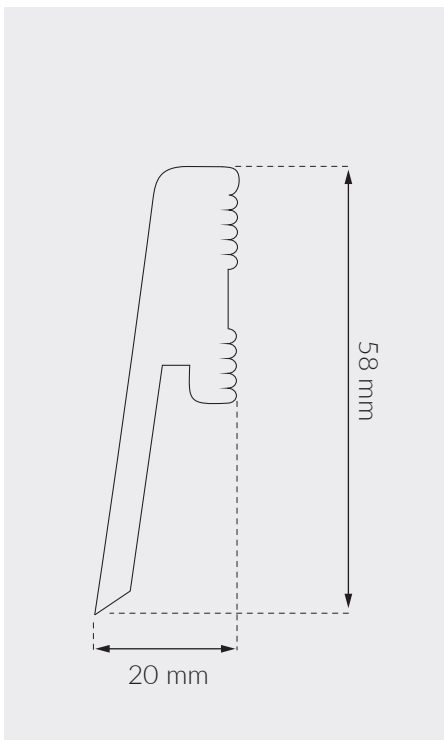

White  
 D0610 5905167766491  
 2,4 m 24 m

- > WATERPROOF
- > IMPACT RESISTANT
- > CLICK OR GLUE
- > EASY WALL RENOVATION
- > DUST AND DIRT BARRIER
- > 100% PVC FREE



	SKIRTING	BLOCKS	CLIPS AND DOWELS	STRONGMAN GLUE	ACRYLIC
/	240 cm	2,3x2,3x15,2 cm	ø 6 mm	-	-
	-	4 pcs = 1 set	20 pcs	1 pc	1 pc
	28,8 m / 24,0 m	10 sets	1200 pcs	12 pcs	12 pcs
EAN	SEE NEXT PAGE	5905167746844	5905167766651	5905167788264	5907584890193

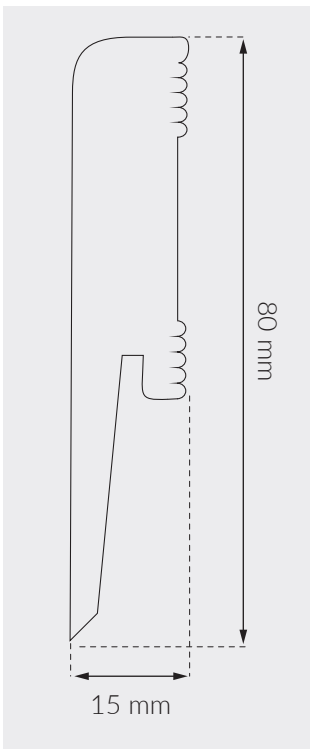

White  
 D0810 5905167766507  
 2,4 m 28,8 m

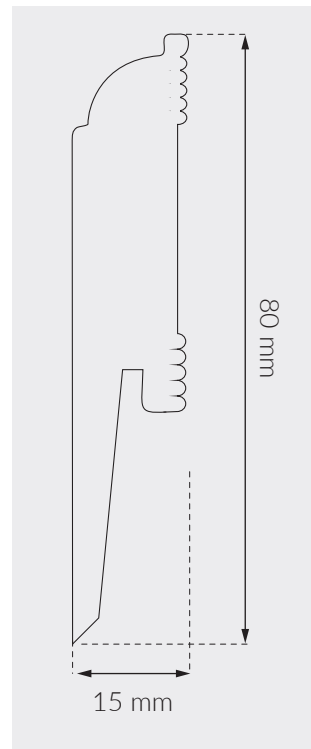

White  
 D0820 5905167766514  
 2,4 m 28,8 m

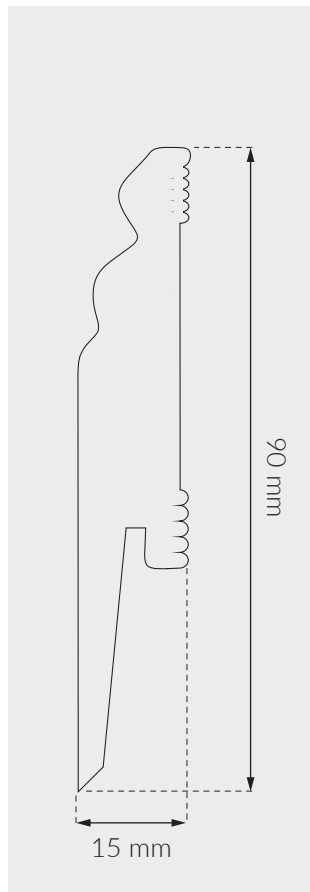

White  
 D0910 5905167766521  
 2,4 m 28,8 m

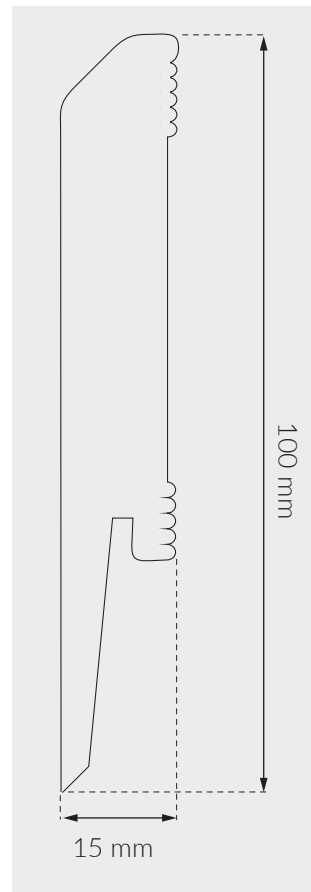

White  
 D1010 5905167766538  
 2,4 m 28,8 m



## ACCESSORIES / UNIVERSAL BLOCK

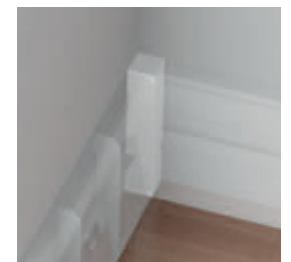
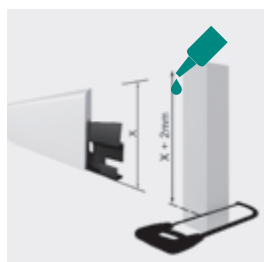
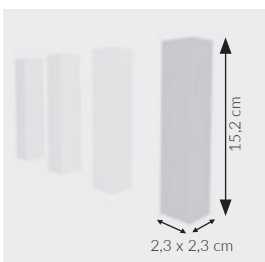



# VEGA



**100%  
PVC  
FREE**



White

PO610 5905167747926

2,4 m 24 m

- > WATERPROOF
- > 4 WAY SYSTEM
- > EASY WALL RENOVATION
- > IMPACT RESISTANT
- > DUST AND DIRT BARRIER
- > 100% PVC FREE

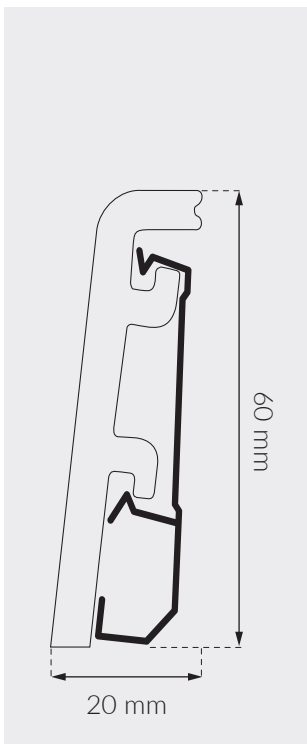

	SKIRTING	BLOCKS	STRONGMAN GLUE	TAPE	ACRYLIC
	240 cm	2,3x2,3x15,2 cm	-	-	-
	-	4 pcs = 1 set	1 pc	1 pc	1 pc
	24 m / 28,8 m	10 sets	12 pcs	24 pcs	12 pcs
EAN	SEE NEXT PAGE	5905167746844	5905167788264	5905167731444	5907584890193

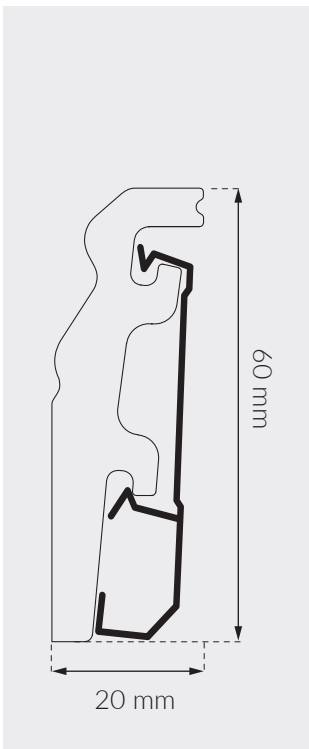

White  
 P0620 5905167755662  
 2,4 m 21,8 m

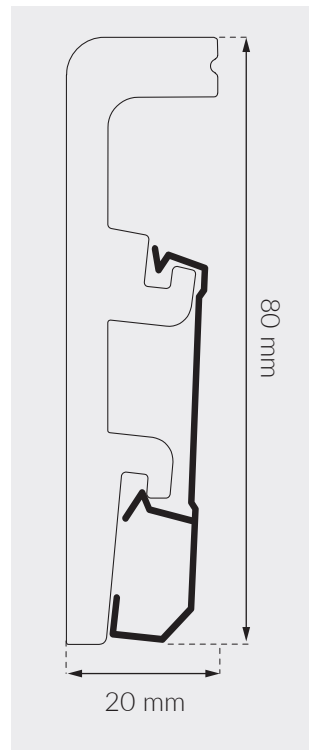

White  
 P0810 5905167734551  
 2,4 m 24 m

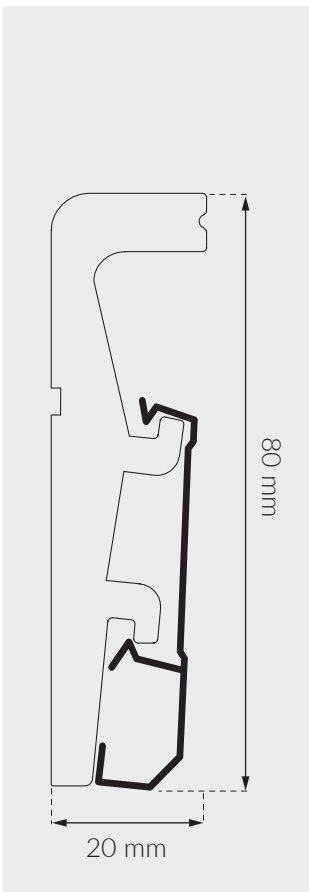

White  
 P0811 5905167734568  
 2,4 m 24 m

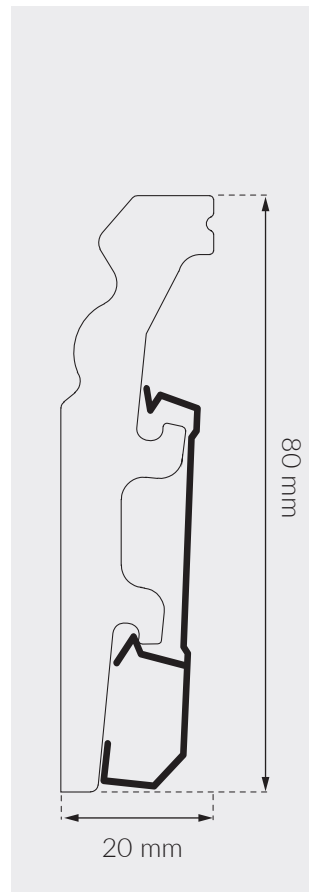

White  
 P0830 5905167755679  
 2,4 m 24 m



ACCESSORIES / UNIVERSAL BLOCK

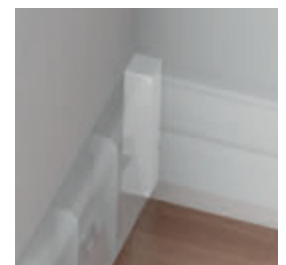
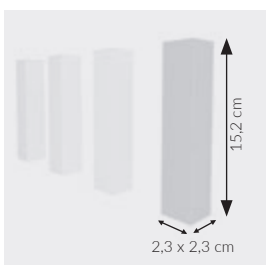

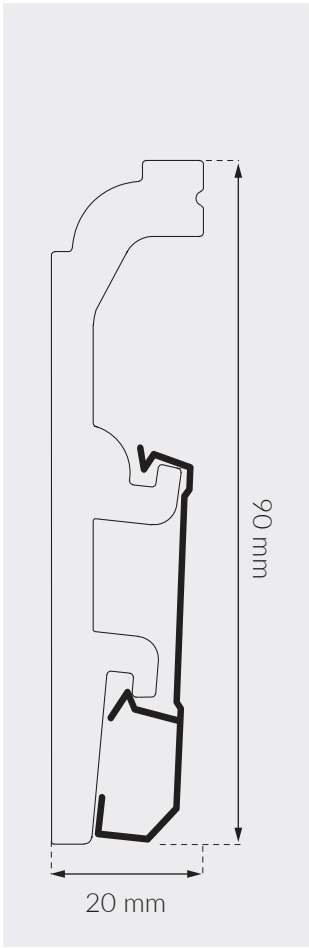

White  
 P0910 5905167734605  
 2,4 m 24 m

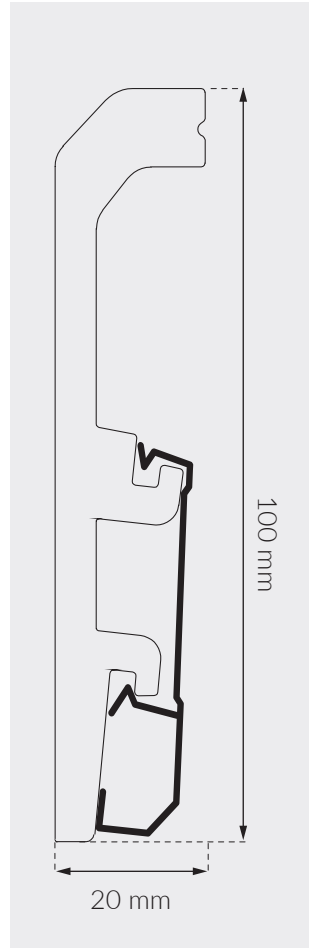

White  
 P1010 5905167734629  
 2,4 m 24 m

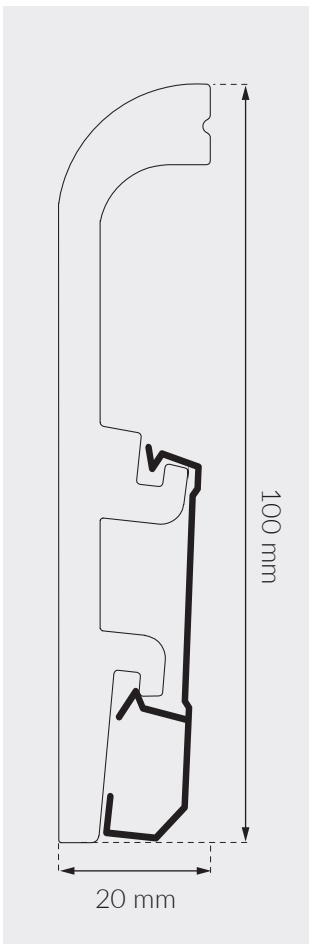

White  
 P1020 5905167734643  
 2,4 m 24 m

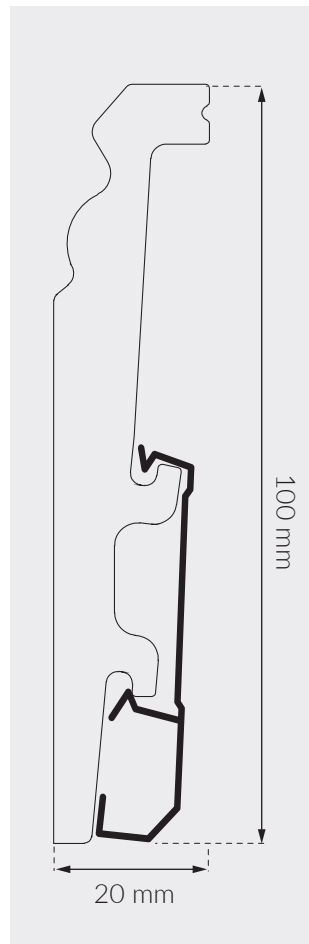

White  
 P1030 5905167755686  
 2,4 m 24 m







# INTEGRA



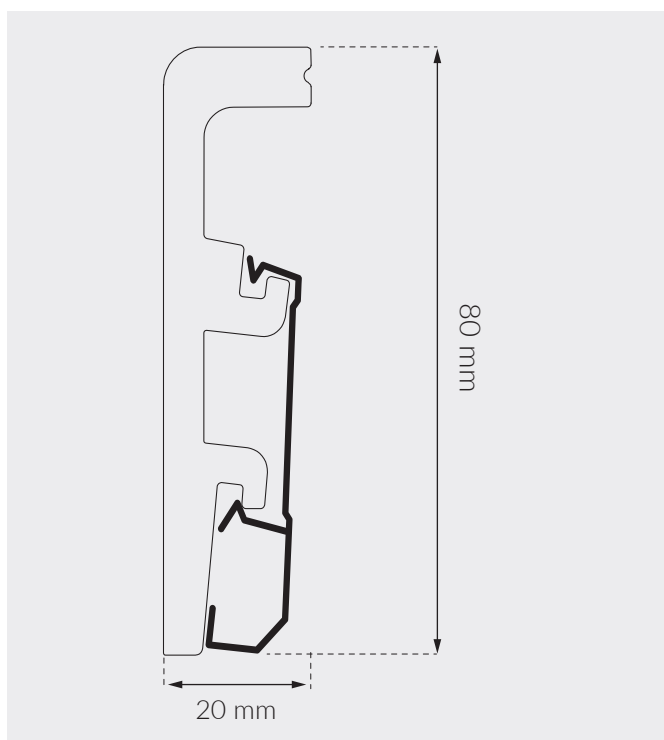
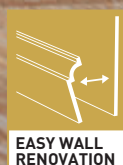

100%  
PVC  
FREE

ALL RIGHTS RESERVED  
**PATENTED**  
ALL RIGHTS RESERVED



- > WATERPROOF
- > 4 WAY SYSTEM
- > IMPACT RESISTANT
- > WOOD STRUCTURE
- > IMPACT RESISTANT
- > WOOD EFFECT
- > EASY WALL RENOVATION
- > 100% PVC FREE

	SKIRTING	STRONGMAN GLUE	TAPE
 / 	240 cm	-	-
	-	1 pc	1 pc
	24 m	12 pcs	24pcs
	504 m	5905167788264	5905167731444





1 | White  
SKIRTING 5905167734353



2 | Aluminium  
SKIRTING 5905167734360



3 | Snow Ash  
SKIRTING 5905167734377



12 | Roma Oak  
SKIRTING 5905167734469



7 | Alabama Oak  
SKIRTING 5905167734414



14 | Oregon Oak  
SKIRTING 5905167734483



5 | City Oak  
SKIRTING 5905167734391



4 | Northern Ash  
SKIRTING 5905167734384



6 | Alaska Ash  
SKIRTING 5905167734407



11 | Persian Oak  
SKIRTING 5905167734452



46 | Davos Oak  
SKIRTING 5905167838228



44 | Manorial Oak  
SKIRTING 5905167838204



9 | Classic Oak  
SKIRTING 5905167734438



8 | Nevada Oak  
SKIRTING 5905167734421



10 | Calvados Oak  
SKIRTING 5905167734445



19 | Natural Oak  
SKIRTING 5905167734537



18 | Loft Oak  
SKIRTING 5905167734520



17 | Dark Walnut  
SKIRTING 5905167734513



45 | Wenge Africa  
SKIRTING 5905167838211



20 | Borneo Oak  
SKIRTING 5905167734544



# MODERN SHAPE PVC COLLECTIONS

FOR ALL FLOOR  
COVERINGS

**INDO**

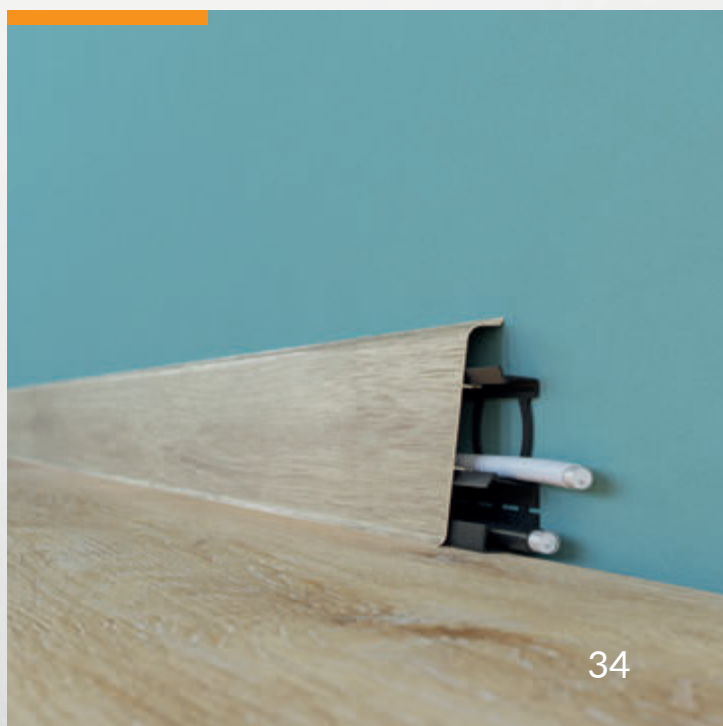

**LARS**







# INDO

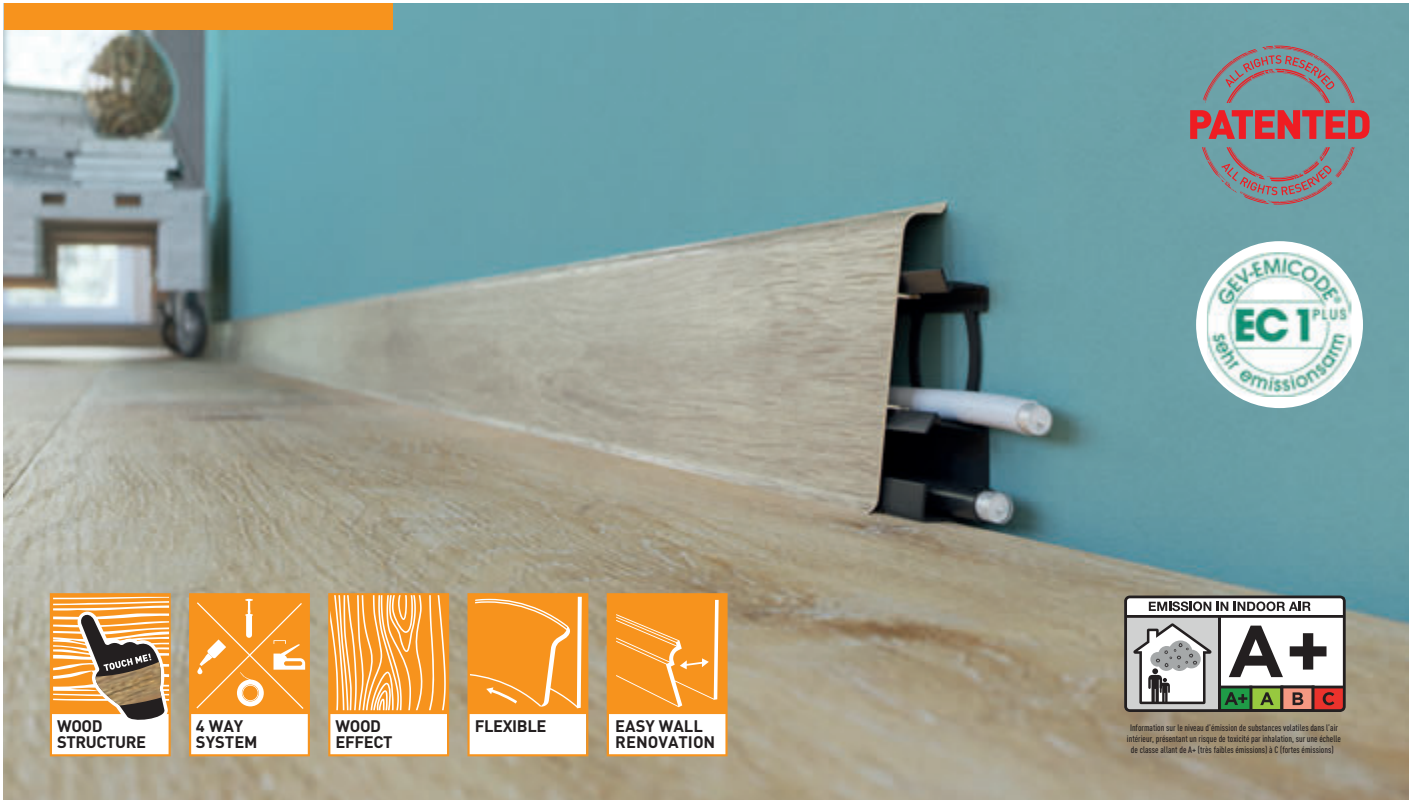

Information sur le niveau d'émission de substances volatiles dans l'air intérieur, présentant un risque de toxicité par inhalation, sur une échelle de classe allant de A+ (très faibles émissions) à C (fortes émissions)

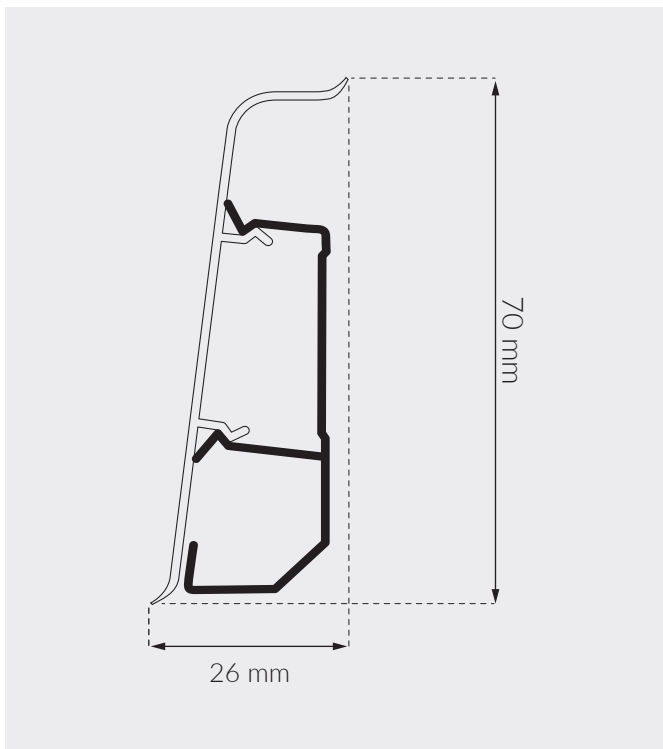

- > WOOD STRUCTURE
- > 4 WAY SYSTEM
- > WOOD EFFECT
- > FLEXIBLE
- > EASY WALL RENOVATION
- > ECO FRIENDLY



01 I White

SKIRTING 5905167725719  
CS PROFILE 40



40 I White Mat

SKIRTING 5905167781685  
CS PROFILE 40

SKIRTING	STRONGMAN GLUE	TAPE	ACCESSORIES				MULTIBOX
250 cm							
-	1 pc	1 pc	2 pcs 20 pack	2 pcs 20 pack	2 pcs 20 pack	1L+1R 20L 20R	1 pc
25 m	12 pcs	24pcs	30 pcs 1440 pcs	30 pcs 360 pcs	30 pcs 360 pcs	30 pcs 720 pcs	30 pcs 720 pcs
875 m	5905167788264						



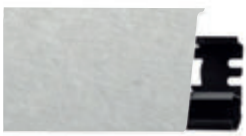

134 | Cambridge  
SKIRTING 5905167806036



133 | Oxford  
SKIRTING 5905167806029  
CS PROFILE 45



41 | Alu Light  
SKIRTING 5905167781340  
CS PROFILE A1



17 | Aluminium  
SKIRTING 5905167729281



25 | Girona Chestnut  
SKIRTING 5905167781326  
CS PROFILE 19



19 | Ontario Oak  
SKIRTING 5905167755006



44 | Bolton Oak  
SKIRTING 5905167799000  
CS PROFILE 2



137 | Selma Oak  
SKIRTING 5905167816981  
CS PROFILE 50



135 | Platinum Oak  
SKIRTING 5905167806067



**NEW!**  
112 | Bradford Oak  
SKIRTING 5905167838235



16 | Caucasian Oak  
SKIRTING 5905167725863



23 | Modena Oak  
SKIRTING 5905167755044  
CS PROFILE 23



131 | Philadelphia Oak  
SKIRTING 5905167806043  
CS PROFILE 46



02 | Northern Ash  
SKIRTING 5905167725726  
CS PROFILE 26



42 | Sand Oak  
SKIRTING 5905167781692  
CS PROFILE 03



20 | Burgos Oak  
SKIRTING 5905167755013  
CS PROFILE 20



03 | Loft Oak  
SKIRTING 5905167725733  
CS PROFILE 03



138 | Pasadena Oak  
SKIRTING 5905167816998  
CS PROFILE 44



**NEW!**  
158 | Monument Oak  
SKIRTING 5905167838259  
CS PROFILE 158



04 | Lingburg Oak  
SKIRTING 5905167725740  
CS PROFILE 04



153 | Yankee Oak  
SKIRTING 5905167825075



05 | Windston Oak  
SKIRTING 5905167725757  
CS PROFILE 31



154 | Sierra Oak  
SKIRTING 5905167825082  
CS PROFILE 07



09 | Manorial Oak  
SKIRTING 5905167725795  
CS PROFILE 65



**NEW!**  
110 | Jersey Oak  
SKIRTING 5905167838242



10 | Bourbon Oak  
SKIRTING 5905167725801  
CS PROFILE 09



139 | Satin Oak  
SKIRTING 5905167817001



43 | Victoria Oak  
SKIRTING 5905167781333



12 | Dark Oak  
SKIRTING 5905167725825  
CS PROFILE 12

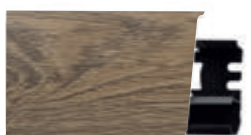

11 | Holm Oak  
SKIRTING 5905167725818  
CS PROFILE 11





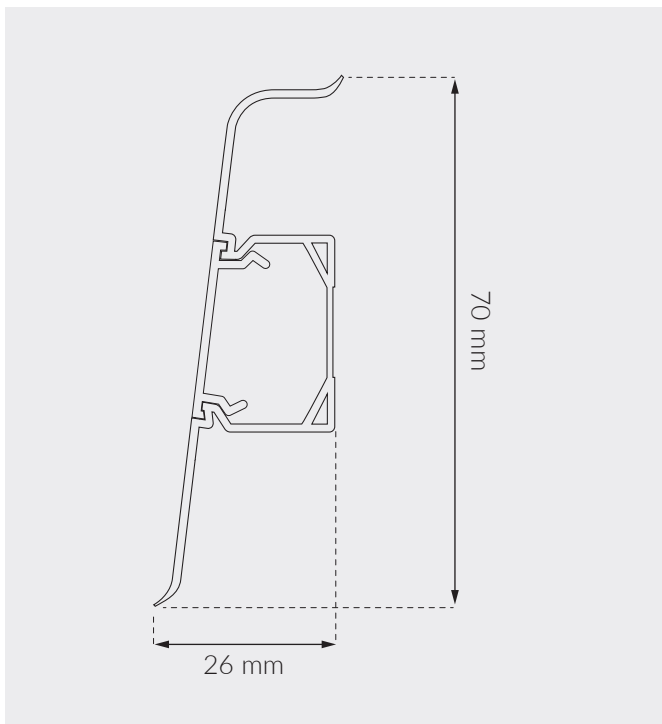

140 | Tasmanian Oak  
SKIRTING 5905167817018  
CS PROFILE 49

# LARS



- > WOOD STRUCTURE
- > EASY INSTALLATION
- > FLEXIBLE
- > MODERN DESIGN
- > ECO FRIENDLY

	SKIRTING	STRONGMAN GLUE	TAPE	ACCESSORIES					MULTIBOX
 250 cm	-	-	-	-	-	-	-	-	-
	-	1 pc	1 pc	2 pcs 20 pack	2 pcs 20 pack	2 pcs 20 pack	20L 1L+1R	20R	1 pc
	50 m	12 pcs	24 pcs	30 pcs 1440 pcs	30 pcs 360 pcs	30 pcs 360 pcs	30 pcs 720 pcs	30 pcs 720 pcs	10 pcs
	1750 m	5905167788264							



40 | White Mat

SKIRTING 5905167783504  
CS PROFILE 40



41 | Alu Light

SKIRTING 5905167817391



25 | Snow Ash

SKIRTING 5905167783474  
CS PROFILE 19



02 | Winterwood Ash

SKIRTING 5905167783399  
CS PROFILE 27



44 | Platinum Oak

SKIRTING 5905167783535



50 | Scandinavian Oak

SKIRTING 5905167783580  
CS PROFILE 48



137 | Selma Oak

SKIRTING 5905167817384  
CS PROFILE 50



16 | Holm Oak

SKIRTING 5905167783429



42 | Arena Oak

SKIRTING 5905167783511  
CS PROFILE 03



03 | Norwegian Oak

SKIRTING 5905167783412  
CS PROFILE 03



04 | Alpine Oak

SKIRTING 5905167783443  
CS PROFILE 04



45 | Swedish Oak

SKIRTING 905167783528



46 | Golden Oak

SKIRTING 5905167783559  
CS PROFILE 09



09 | Noble Oak

SKIRTING 5905167783436  
CS PROFILE 29



47 | Tatra Oak

SKIRTING 5905167783542



32 | Elegant Oak

SKIRTING 5905167783498  
CS PROFILE 39



12 | Brazilian Walnut

SKIRTING 5905167783450  
CS PROFILE 12



14 | Wood Wenge

SKIRTING 5905167783405

## ACCESSORIES





# MACK



**MODERN  
DESIGN**

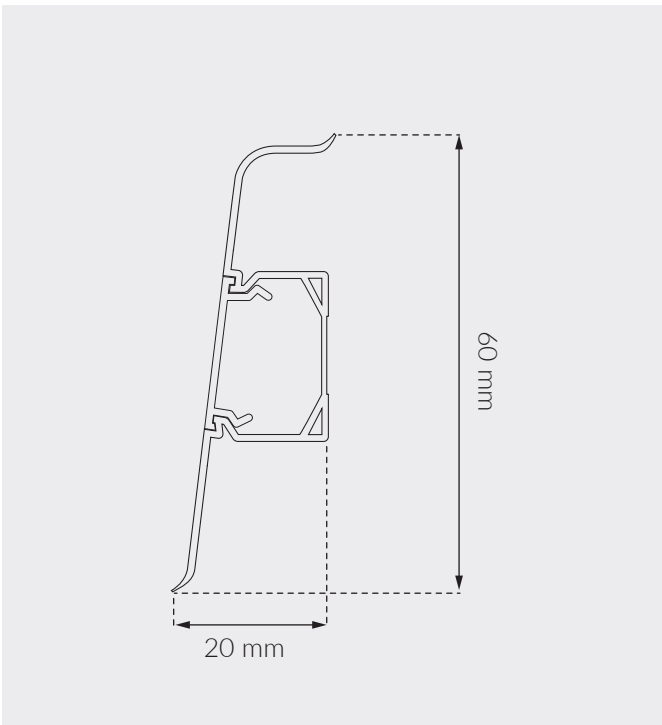

- > MODERN DESIGN
- > EASY INSTALLATION
- > FLEXIBLE
- > ECO FRIENDLY

	 SKIRTING	 STRONGMAN GLUE	 TAPE	 ACCESSORIES	 MULTIBOX																			
 250 cm	-	-	-	-	-																			
 -	1 pc	1 pc	<table border="0"> <tr> <td>2 pcs</td> <td>2 pcs</td> <td>2 pcs</td> <td colspan="2">1L+1R</td> </tr> <tr> <td>25 pack</td> <td>25 pack</td> <td>25 pack</td> <td>25L</td> <td>25R</td> </tr> <tr> <td>30 pcs</td> <td>30 pcs</td> <td>30 pcs</td> <td>30 pcs</td> <td>30 pcs</td> </tr> <tr> <td>1440 pcs</td> <td>360 pcs</td> <td>360 pcs</td> <td>720 pcs</td> <td>720 pcs</td> </tr> </table>	2 pcs	2 pcs	2 pcs	1L+1R		25 pack	25 pack	25 pack	25L	25R	30 pcs	30 pcs	30 pcs	30 pcs	30 pcs	1440 pcs	360 pcs	360 pcs	720 pcs	720 pcs	1 pc
2 pcs	2 pcs	2 pcs	1L+1R																					
25 pack	25 pack	25 pack	25L	25R																				
30 pcs	30 pcs	30 pcs	30 pcs	30 pcs																				
1440 pcs	360 pcs	360 pcs	720 pcs	720 pcs																				
 50 m	12 pcs	24 pcs	-	-	10 pcs																			
 2400 m	5905167788264	5905167731444	-	-	-																			



40 | White Matt

SKIRTING 5905167803554

CS PROFILE 40



41 | Alu Light

SKIRTING 5905167803721

CS PROFILE 41



25 | Girona Chestnut

SKIRTING 5905167803578

CS PROFILE 42



107 | Bolton Oak

SKIRTING 5905167803585

CS PROFILE 19

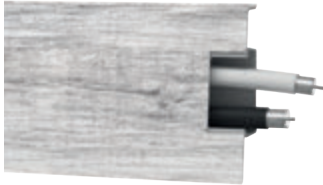

131 | Philadelphia Oak

SKIRTING 5905167803622

CS PROFILE 19



135 | Platinum Oak

SKIRTING 5905167803615

CS PROFILE 15



16 | Caucasian Oak

SKIRTING 5905167803639

CS PROFILE 39



02 | North Ash

SKIRTING 5905167803592

CS PROFILE 26



42 | Arena Oak

SKIRTING 5905167803646

CS PROFILE 46



138 | Pasadena Oak

SKIRTING 5905167825280

CS PROFILE 44



03 | Loft Oak

SKIRTING 5905167803653

CS PROFILE 03



04 | Lingburg Oak

SKIRTING 5905167803660

CS PROFILE 04



153 | Yankee Oak

SKIRTING 5905167825297

CS PROFILE 153

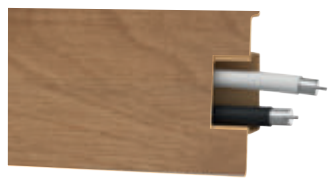

136 | Antique Oak

SKIRTING 5905167803677

CS PROFILE 77



154 | Sierra Oak

SKIRTING 5905167825303

CS PROFILE 07

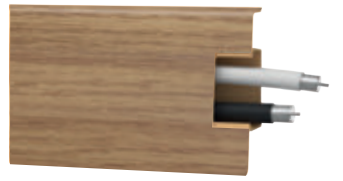

46 | Golden Oak

SKIRTING 5905167825273

CS PROFILE 09



86 | Laplant Oak

SKIRTING 5905167803684

CS PROFILE 84



132 | Edmonton Oak

SKIRTING 5905167803707

CS PROFILE 07

## ACCESSORIES



# TRADITIONAL PVC COLLECTIONS

FOR ALL FLOOR  
COVERINGS

**LM60**

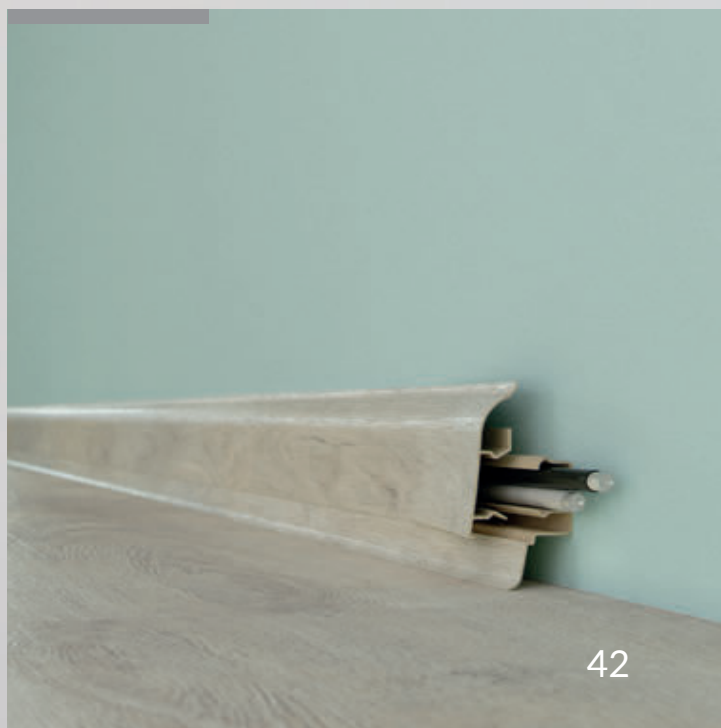

**LM55**

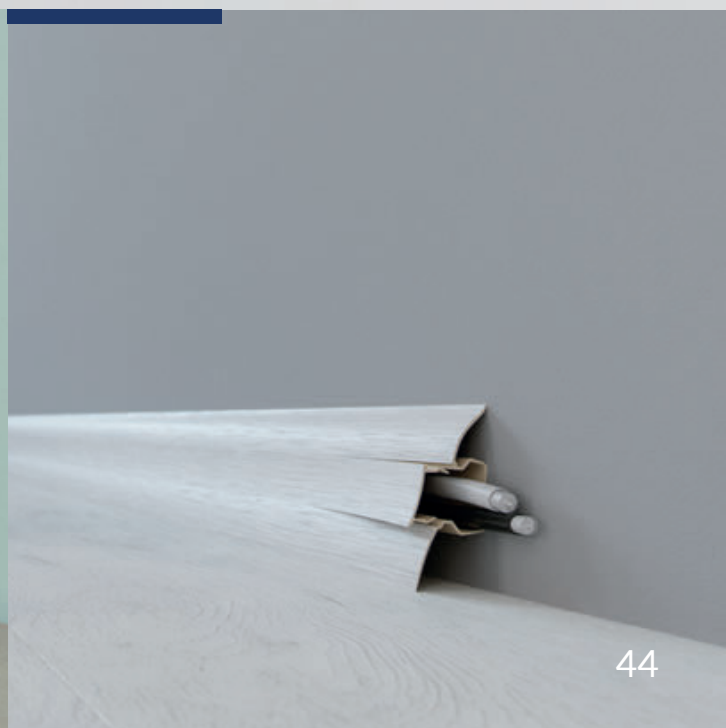





# LM60

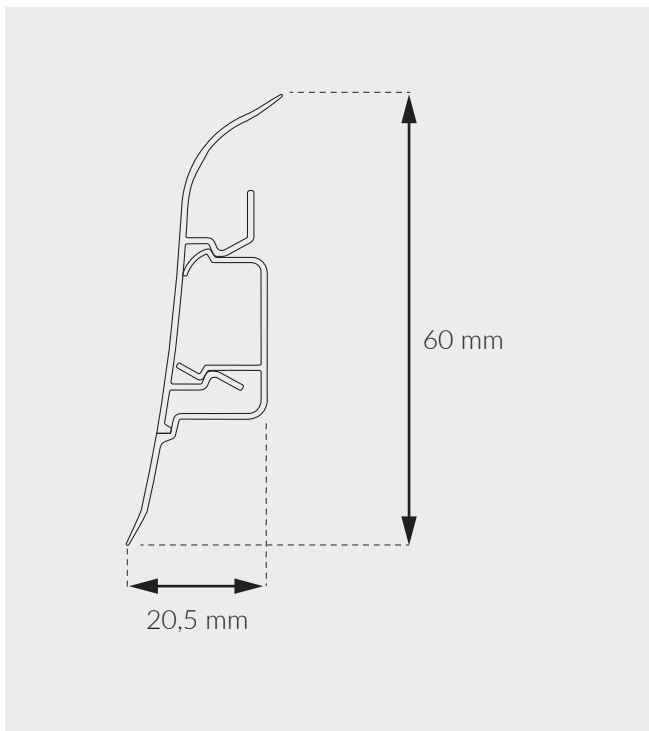

- > WOOD EFFECT
- > EASY WALL RENOVATION
- > FLEXIBLE
- > ECO FRIENDLY PVC

	SKIRTING	ACCESSORIES					MULTIBOX
	250 cm	-	-	-	-	-	-
	-	2 pcs	2 pcs	2 pcs	1L+1R	1L+1R	1 pc
	-	25 pack	25 pack	25 pack	25L+25R	25L+25R	-
	50 m	30 pcs	30 pcs	30 pcs	30 pcs	30 pcs	10 pcs
	1750 m	1440 pcs	360 pcs	360 pcs	1440 pcs	1440 pcs	5906735698503



34 | White  
SKIRTING 5905167749043



39 | Aluminium  
SKIRTING 5907749020014



107 | Bolton Oak  
SKIRTING 5905167752944

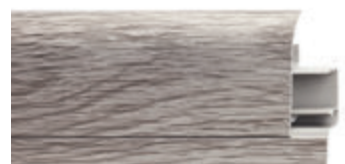

99 | Kendari Oak  
SKIRTING 5905167709542



44 | Golden Oak  
SKIRTING 5907749020083



58 | Country Oak  
SKIRTING 5905167662946



23 | Ash  
SKIRTING 5907749001891



109 | Sevilla Oak  
SKIRTING 5905167753149



77 | Sand Oak  
SKIRTING 5905167662953



65 | Canyon Oak  
SKIRTING 5905167662656



52 | Ardennes Oak  
SKIRTING 5907749020311



49 | Liverpool Oak  
SKIRTING 5907749020144



70 | White Oak  
SKIRTING 5905167663226



16 | Antique Oak  
SKIRTING 5906735694451



86 | Laplant Oak  
SKIRTING 5907749049282



72 | Bourbon Oak  
SKIRTING 5905167663264



63 | Tosca Oak  
SKIRTING 5905167663349



24 | Highland Oak  
SKIRTING 5907749012064



94 | Victoria Oak  
SKIRTING 5905167703175



74 | Rustic Oak  
SKIRTING 5905167663295



97 | Lagos Oak  
SKIRTING 5905167709528

## ACCESSORIES





# LM55



- > FLEXIBLE ADAPTATION
- > WOOD EFFECT
- > ECO FRIENDLY PVC

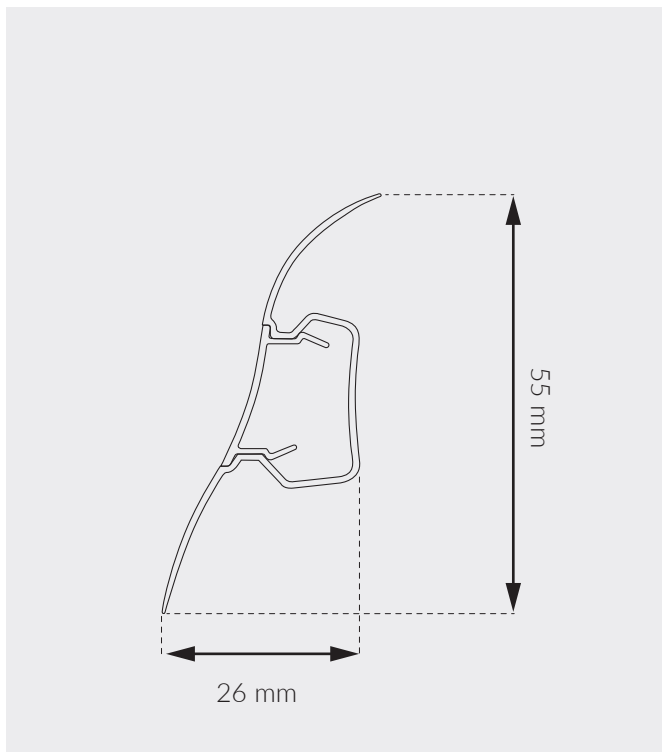

	SKIRTING	ACCESSORIES					MULTIBOX
	250 cm	-	-	-	-	-	-
	-	2 pcs	2 pcs	2 pcs	1L+1R		1 pc
		25 pack	25 pack	25 pack	25L	25R	
	50 m	30 pcs	30 pcs	30 pcs	30 pcs	30 pcs	10 pcs
		1440 pcs	360 pcs	360 pcs	1440 pcs	1440 pcs	
	1750 m						



101 | White Matt  
SKIRTING 5905167735558



108 | Aspen Oak  
SKIRTING 5905167788349



107 | Girona Chestnut  
SKIRTING 5905167788332



45 | Grey Acacia  
SKIRTING 5907749020236



104 | Sardinia Oak  
SKIRTING 5905167741948



48 | Golden Oak  
SKIRTING 5907749020243



58 | Country Oak  
SKIRTING 5905167662748



103 | Havana Oak  
SKIRTING 5905167741153



77 | Sand Oak  
SKIRTING 5905167734810



49 | Belfast Oak  
SKIRTING 5907749020250



23 | Ash  
SKIRTING 5907749001174



102 | Almelo Oak  
SKIRTING 5905167741146



65 | Canyon Oak  
SKIRTING 5905167662762



110 | Ginkgo Biloba  
SKIRTING 5905167788363



47 | Liverpool Oak  
SKIRTING 5907749014853



109 | Ageing Oak  
SKIRTING 5905167788356



20 | Savoyen Oak  
SKIRTING 5906735647785



28 | Pecan  
SKIRTING 5907749001228



34 | Alaska Oak  
SKIRTING 5907749014716



16 | Antique Oak  
SKIRTING 5906735647747



85 | North Oak  
SKIRTING 5907749049329



67 | Classic Light Oak  
SKIRTING 5905167662885



86 | Laplant Oak  
SKIRTING 5905167670293



83 | Romantic Oak  
SKIRTING 5905167662915



26 | Dark Oak  
SKIRTING 5907749001204



112 | Jupiter Walnut  
SKIRTING 5905167788387



22 | Wenge Africa  
SKIRTING 5907749001167

## ACCESSORIES



# TRADITIONAL MDF COLLECTION

FOR ALL FLOOR  
COVERINGS

## CAVARE



## PAINT IT

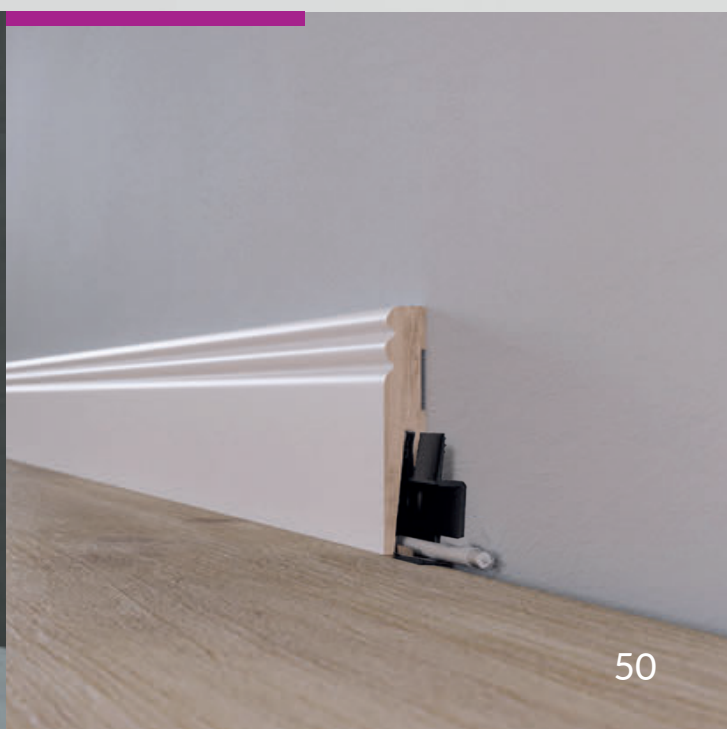



# DIAMOND

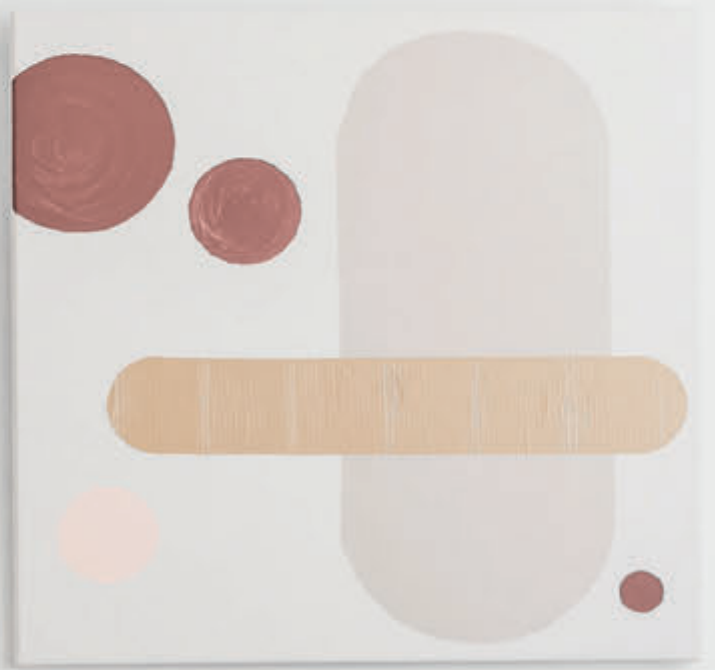

# CAVARE

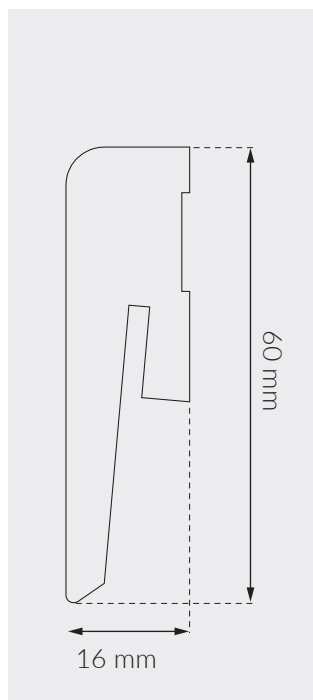

White  
 ML0602 / 5905167817742  
 2,4 m 24 m



- > FULL LACQUER
- > ECO LACQUER
- > MODERN DESIGN
- > IMPACT RESISTANT
- > CLICK OR GLUE

	SKIRTING	CLIPS AND DOWELS	STRONGMAN GLUE	ACRYLIC
	242 cm	ø 6 mm	-	-
	-	25 pcs	1 pc	1 pc
	24,2 m	1500 pcs	12 pcs	12 pcs
EAN	SEE NEXT PAGE	5905167674437	5905167788264	5907584890193

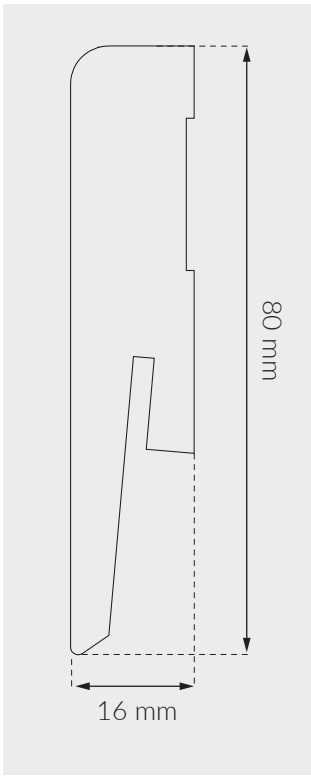

White

ML 0801 5905167817810

2,4 m 24 m

Oslo Gray

5905167817834

2,4 m 24 m

Gray

5905167817780

2,4 m 24 m

Taupe

5905167817841

2,4 m 24 m



RAL 7035



RAL 7006



RAL 7042

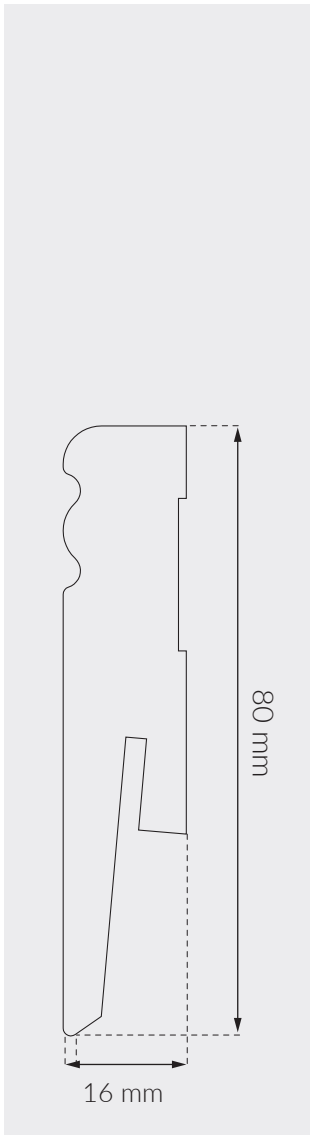

White

ML0802 5905167817858

2,4 m 24 m

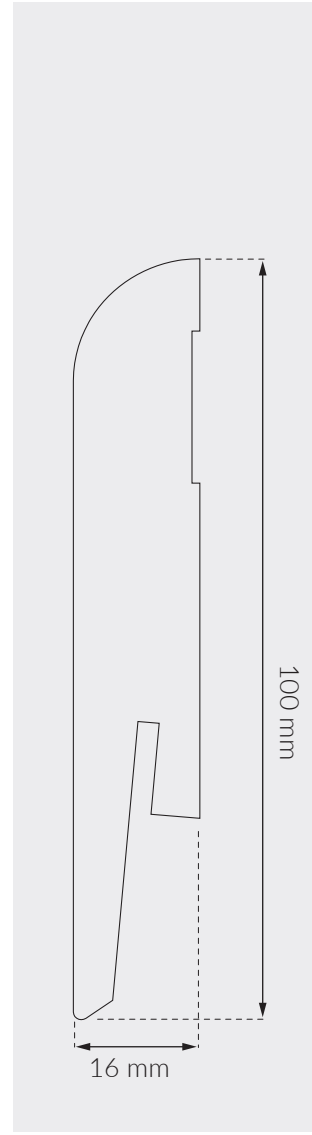

White

ML1004 5905167817865

2,4 m 24 m





# PAINT IT

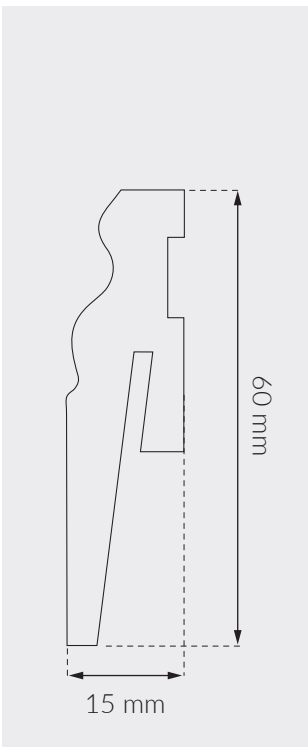
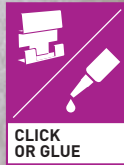

White  
 MP0601 5905167674338  
 2,42 m 2,42 m

- > KEEP IT WHITE OR PAINT IT
- > EASY WALL RENOVATION
- > CLICK OR GLUE



	 SKIRTING	 BLOCKS	 CLIPS AND DOWELS	 STRONGMAN GLUE	 ACRYLIC
	242 cm	1,8x1,8x11,2 cm	ø 6 mm	-	-
	-	4 pcs = 1 set	25 pcs	1 pc	1 pc
	24,2 m	10 sets	1500 pcs	12 pcs	12 pcs
EAN	SEE NEXT PAGE	5905167736937	5905167674437	5905167788264	5907584890193

White

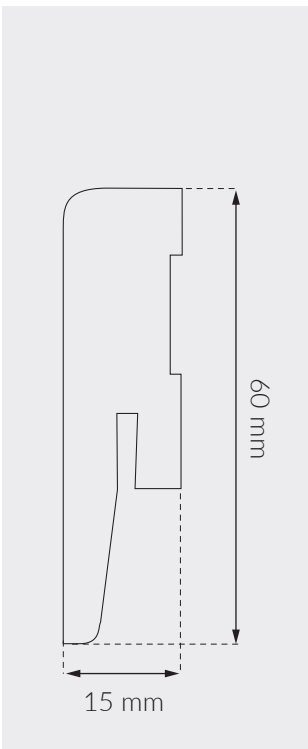

MP0602 5905167754986

 2,42 m  2,42 m



White

MP0801 5905167674345

 2,42 m  2,42 m

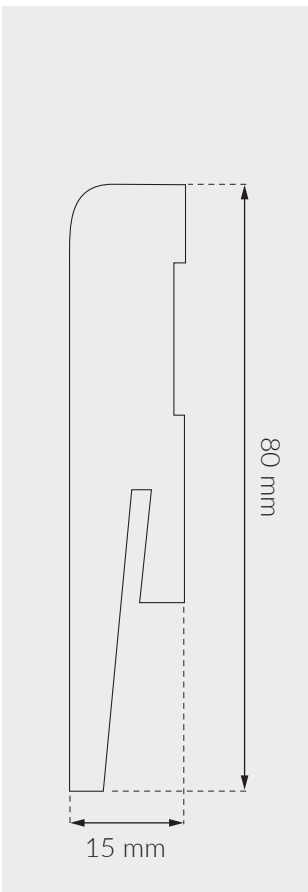

White

MP0802 5905167674352

 2,42 m  2,42 m

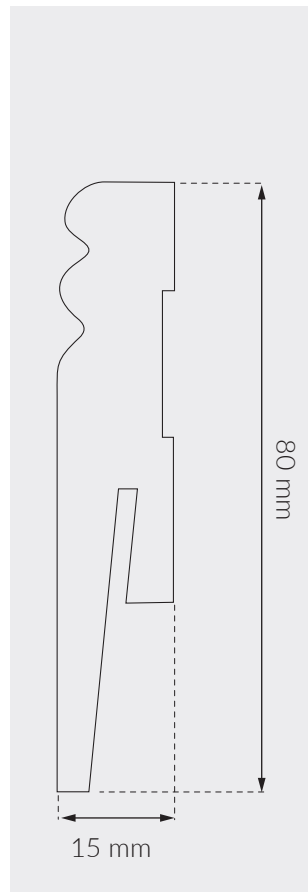

## ACCESSORIES / UNIVERSAL BLOCK

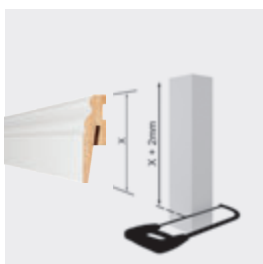
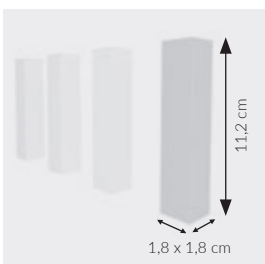

White

MP0901 5905167674369

2,42 m 2,42 m

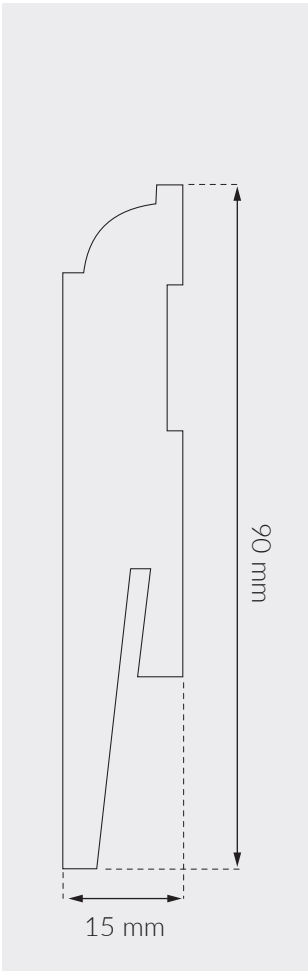

White

MP1001 5905167674376

2,42 m 2,42 m

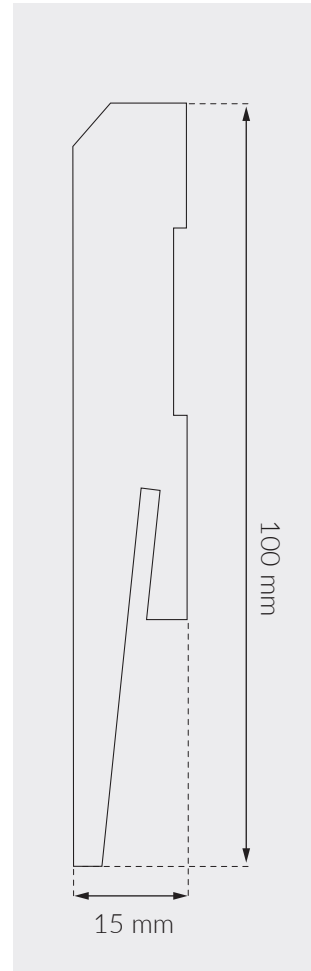

White

MP1002 5905167674383

2,42 m 2,42 m

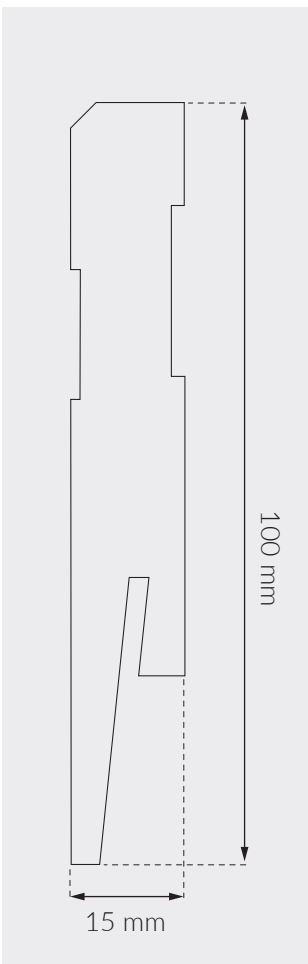

White

MP1003 5905167674390

2,42 m 2,42 m

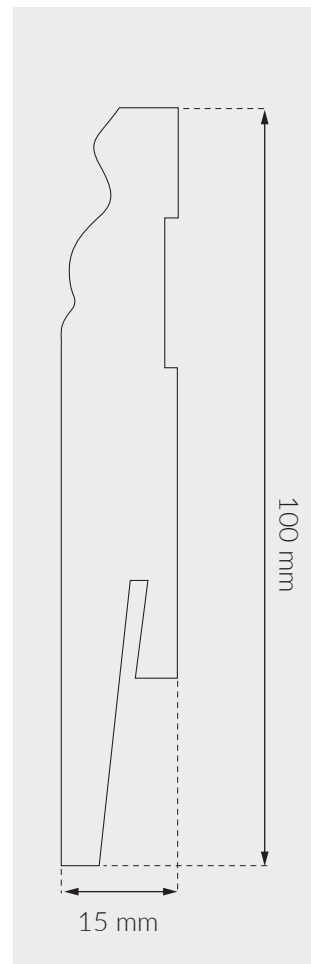



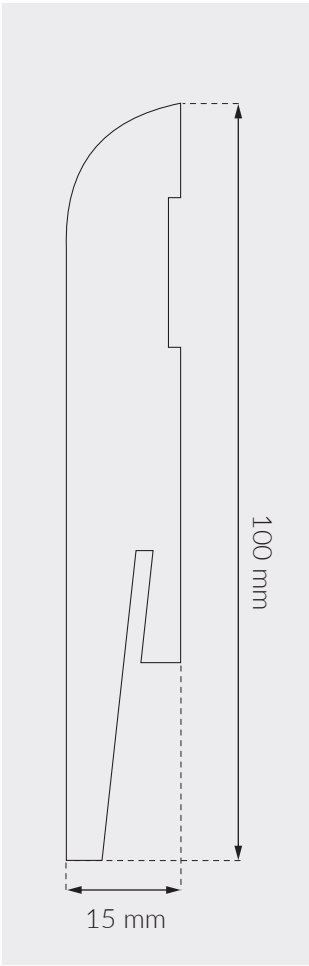

White  
 MP1004 5905167674406  
 2,42 m 2,42 m

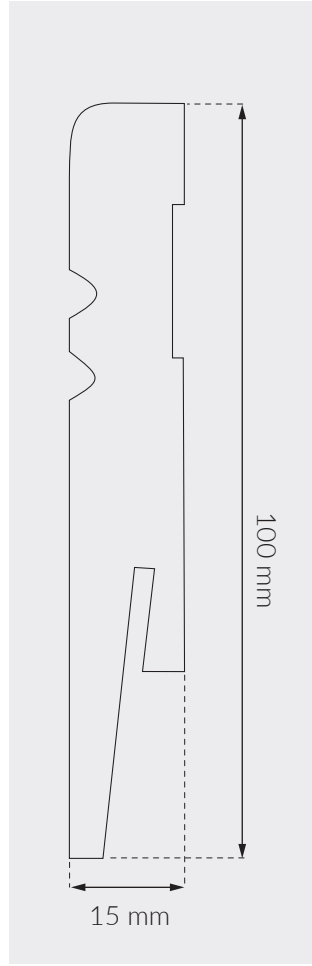

White  
 MP1005 5905167674413  
 2,42 m 2,42 m

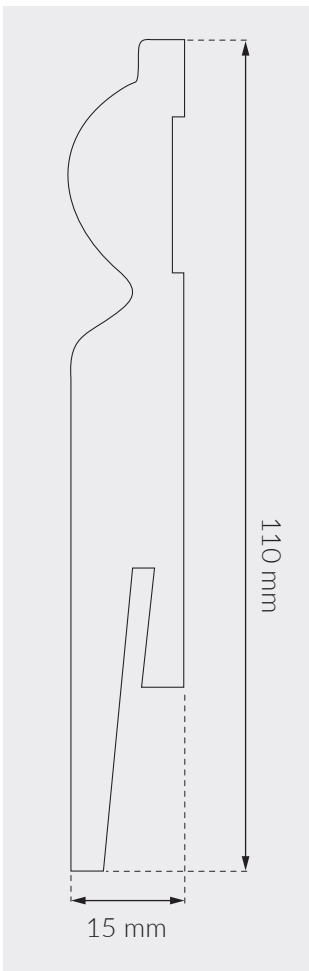

White  
 MP1101 5905167674420  
 2,42 m 2,42 m

# DIAMOND

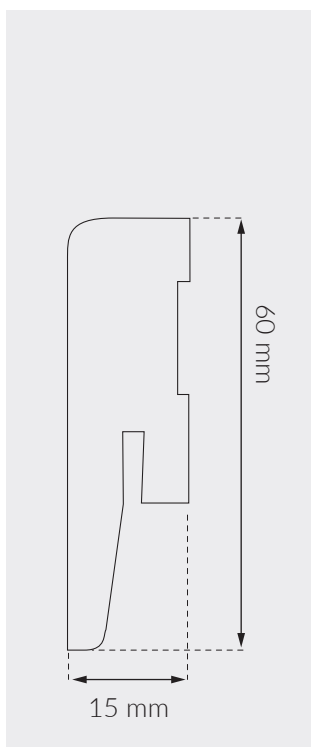

White

GP0601 5905167766668

2,4 m 24 m

- > GLOSSY SURFACE
- > EASY WALL RENOVATION
- > CLICK OR GLUE



					
	SKIRTING	BLOCKS	CLIPS AND DOWELS	STRONGMAN GLUE	ACRYLIC
	242 cm	1,8x1,8x11,2 cm	ø 6 mm	-	-
	-	4 pcs = 1 set	25 pcs	1 pc	1 pc
	24,2 m	10 sets	1500 pcs	12 pcs	12 pcs
EAN	SEE NEXT PAGE	5905167736937	5905167674437	5905167788264	5907584890193

White  
 GP0801 5905167766675  
 2,4 m  24 m

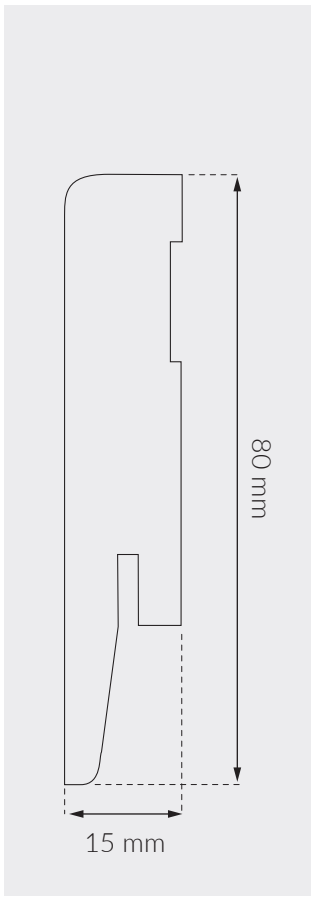

White  
 GP1001 5905167766682  
 2,4 m  24 m

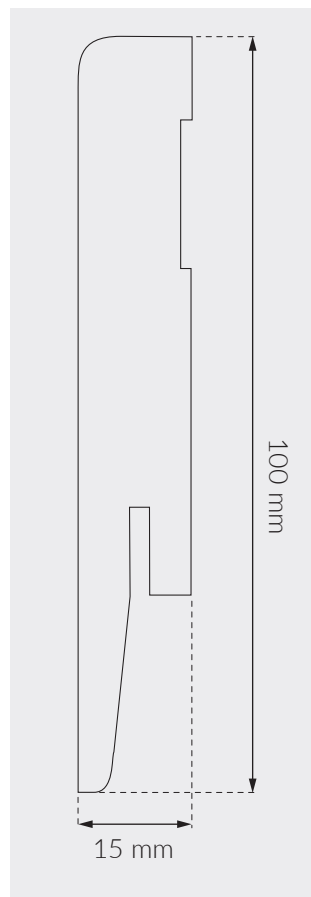

## ACCESSORIES / UNIVERSAL BLOCK

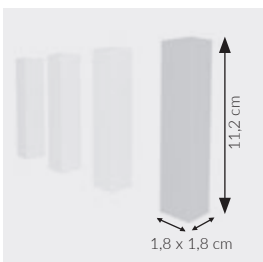



# UNIVERSAL PROFILES

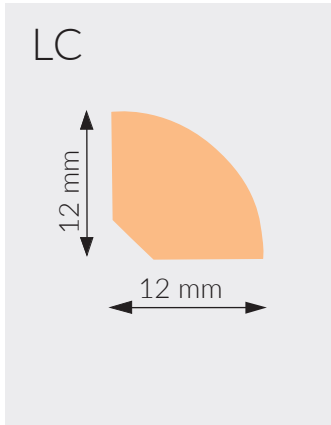

QUARTER ROUND PROFILE

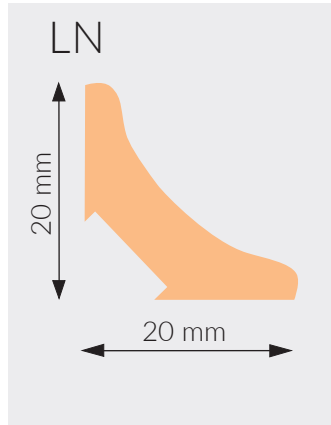

CORNER PROFILE

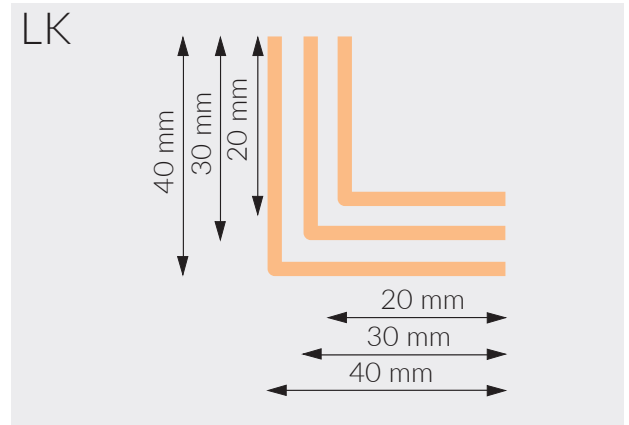

ANGLE BARS WITH BOTH SIDES PRINTED

## LC 12 x 12 mm

00	5907584871017
01	5907584871024
02	5907584871055
04	5907584871048
08	5907584871062
11	5907584871031

2,5 m / 50 m

## LN 20 x 20 mm

00	5907584871109
01	5907584871116
02	5907584871147
04	5907584871130
08	5907584871154
11	5907584871123

2,5 m / 50 m

## LK 20 x 20 mm

00	5907584871208
01	5907584871215
02	5907584871246
07	5907584871222
08	5907584871239
11	5907584871253
12	5906735622478

2,75 m / 55 m

## LK 30 x 30 mm

5907584871307
5907584871314
5907584871345
5907584871321
5907584871338
5907584871352
5906735622485

2,75 m / 55 m

## LK 40 x 40 mm

5907584871406
5907584871413
5907584871444
5907584871420
5907584871437
5907584871451
5906735622492

2,75 m / 55 m



## COLORS



Black



White



Beech



White Beech



Dark Oak



White Oak



Grey Ash



Mahogany

# ACCESSORIES



## CLIPS AND DOWEL FOR TORE, VIGO, MDF COLLECTION

cm /  $\varnothing$  6 mm    20 pcs    1200 pcs    EAN 5905167826737



## CLIPS AND DOWEL FOR DORA

cm /  $\varnothing$  6 mm    20 pcs    1200 pcs    EAN 5905167766651



## TAPE

cm / -    1 pc    24 pcs    EAN 5905167731444

## STRONGMAN GLUE

cm / -    1 pc    300 ml    12 pcs    EAN 5905167788264



## ACRYL

cm / -    1 pc    300 ml    12 pcs    EAN 5907584890193

## BLOCKS FOR DORA AND VEGA

cm / 2,3x2,3x15,2 cm    4 pcs = 1 set    10 sets    EAN 5905167746844

## BLOCKS FOR MDF

cm / 1,8x1,8x11,2 cm    4 pcs = 1 set    10 sets    EAN 5905167736937



# SYMBOLS



**100% WATERPROOF**  
Clean your floor without any risk – non-deforming, water resistant board!



**FLEXIBLE**  
Flexible adaptation to uneven walls.



**IMPACT RESISTANT**  
Highest resistance and stability.

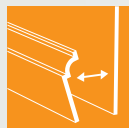

**EASY WALL RENOVATION**  
Possibility of unfixing skirtings in order to paint or hide TV or audio cable (max 230V).



**KEEP IT WHITE OR PAINT IT**  
The board which can be painted. Possibility of fully matching the board colours to the walls of the room.



**4 WAY SYSTEM**  
Solid, fast, simple installation and deinstallation, for any type of wall.



**GLOSSY SURFACE**  
Brilliant shiny finishing.

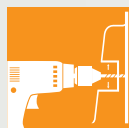

**EASY INSTALLATION**  
Wide installation channel provides an easy access for a drill or screwdriver. It makes installation quicker and easier.



**WOOD EFFECT**  
The ideal colour and design match, 100% accurate representation of wooden colors.



**MITRE SAW**  
The possibility of cutting corners with a mitre saw.



**MANUAL CUTTING**  
The possibility of cutting corners with a hand saw.



**DUST AND DIRT BARRIER**  
Smooth surface without micropores and harder COEX is perfect for easy cleaning and non adhering dirt and dust.



**CLICK OR GLUE**  
Install the skirting in two ways: glue skirting directly to the wall, or clip - strip easily and remove at any time.



**MODERN DESIGN**  
Unique shape was created for a modern interiors and its simplicity is an answer even for the most demanding.



**WOOD STRUCTURE**  
Structure embossed on the surface, perfectly imitating the real wood.



**JUST GLUE**  
Glue skirting directly to the wall.



**FULL LACQUER**  
Covered from 3 sides with lacquer.



**ECO FRIENDLY**  
The board made of environmentally friendly material.



**DEEP MATT**  
Thanks to totally new, multi-step process of production we get a deep matt surface.



**100% PVC FREE**  
The board made of environmentally friendly material.



**SUPER FLEXIBLE**  
Flexible adaptation to uneven walls.



**MDF**  
Skirting board made from MDF covered with coated paper which increases durability. It's not necessary to paint the skirting board before the first installation.



**GLUING CHANNEL**  
special glue channel to prevent the excess of glue from slipping out.



**PATENTED**  
Technology is a patented.



**NO SILICONE NEEDED**  
Integrated and large rubber edges in the color of the skirting adapt to uneven surfaces and give a solid connection with wall and floor resulting in 100% waterproof barrier



The materials awarded this label comply with very stringent health and environmental requirements.



**DIGITAL DESIGN**  
Due to the highly advanced technology of digital printing - piezoelectric UV LED with high-resolution (up to 1800 dpi)



**HYBRID TECHNOLOGY**  
The product that combines the advantages of polymer products, like impact resistance and waterproof with high quality surface of lacquered MDF skirtings.

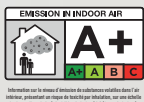

The materials awarded this label comply with very stringent health and environmental requirements.





The catalogue is a free of charge presentation of products of Decora S.A. and acc. to valid law it is not a commercial offer. Colors and textures of the products in pictures may differ from real ones because of limited printing technologies. Decora S.A. reserves its right to alter availability of the products on some markets and at some distributors. The products included in the catalogues do not pose a complete offer of Decora S.A.

## CHECK OUR COMPLEMENTARY PRODUCTS:



**UNDERLAYS**



**FLOOR PROFILES**



**VINYL FLOOR**



**Arbiton**  
FLOOR EXPERT

Decora S.A.  
ul. Prądyńskiego 24a  
63-000 Środa Wlkp., Polska  
tel.: +48 61 28 64 200  
fax: +48 61 28 54 975  
e-mail: [sales@decora.pl](mailto:sales@decora.pl)  
[www.arbiton.com](http://www.arbiton.com)